

## TABLE OF CONTENTS

MP40 & derivatives + actuators .....	Pages: 2 to 7
MP90 & derivatives + actuators .....	Pages: 8 to 11
MP110 & derivatives	
MP100-.. - Plug-on connection socket	
MP110-Z.. - Protective terminal cover .....	Pages: 12 to 17
+ actuators .....	Pages: 18 to 21
MP210 & derivatives	
MP210-0/.. PG and type CSA	
MP215-0/.. (IP68) .....	Pages: 22 to 25
+ actuators .....	Pages: 26 to 29
MP320 & derivatives connections,	
+ actuators .....	Pages: 30 to 37
MP420 & derivatives connections,	
+ actuators .....	Pages: 38 to 41
MP720 & derivatives assembling instructions,	
+ actuators .....	Pages: 42 to 47



The products offered by Microprecision Electronics SA, with their high precision and great reliability, have several international approval certificates. Moreover, the company is certified since 1993 according to the ISO9001/EN29001 standard.

# SERIES MP40 & DERIVATIVES

## MP40

### MICROSWITCHES

The microswitches MP40 & derivatives are snap-action changeovers, simple switching action, connection by screw lugs.

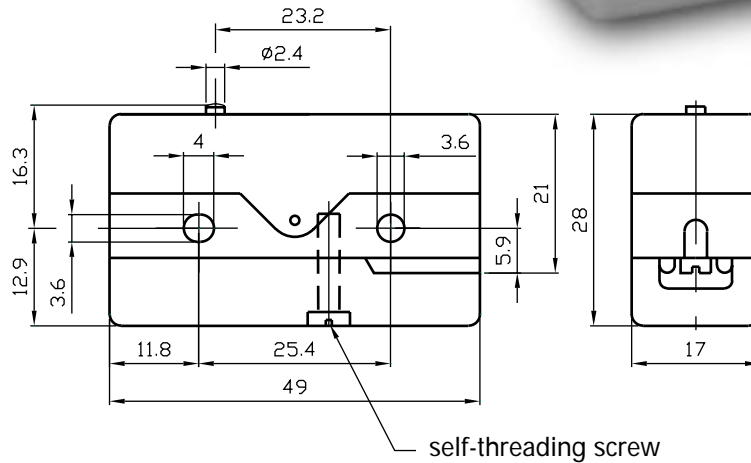

#### GENERAL CHARACTERISTICS, MODELS MP40

Approval	: 
Switching rating	: 10A 400VAC
Degree of protection	: Housing IP40 Terminals IP00 Cover IP20
Class of protection	: II
Micro-switching	: $\mu$
Distance between contacts	: 0,3 mm
Up to standard	: EN61058-1:92 + A1:93
Frequent functioning	: 50 E3
Mechanical life	: 50 x 10 <sup>6</sup> operations
Snap-action mechanism	: Beryllium coppers leaf spring with self-cleaning contacts
Actuators	: Overall dimensions in stainless steel
Dimensions	: DIN 41 635, E-form
Housing	: PA6T/X reinforced with glass fibre Auto-extinguishing according to UL94 V-O
Certified temperature	: - 40°C to +130°C

REFERENCE CODE OF THE ARTICLE

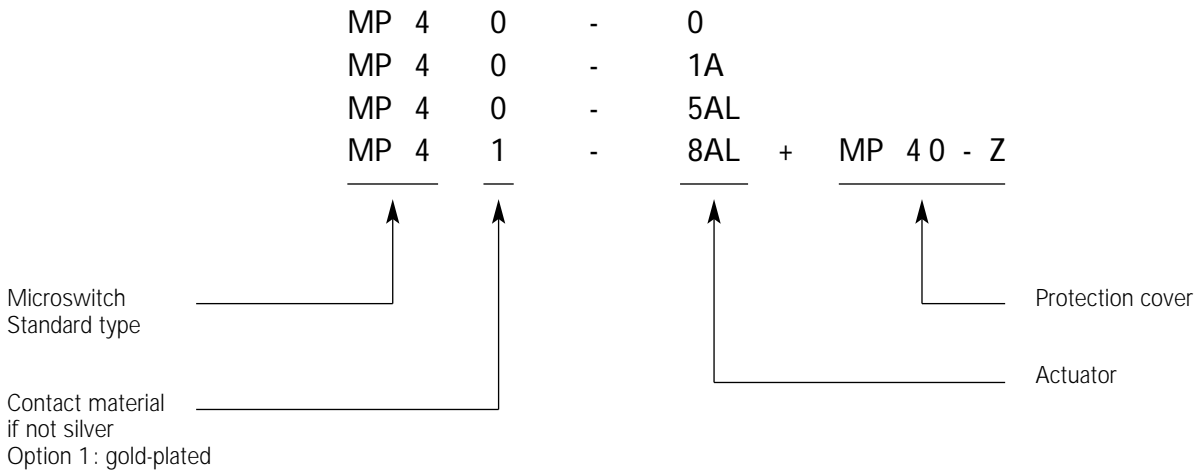

CIRCUIT DIAGRAM

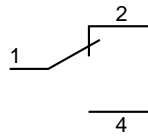

CONNECTION TYPE

MP40  
Screw terminals

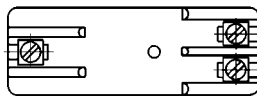

MP50  
Terminals with soldering lugs

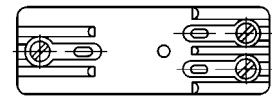

LATERAL FIXING

An **insulating plate** must be inserted between a microswitch with **protruding terminals** and the **fixing surface** if the surface is **metal**

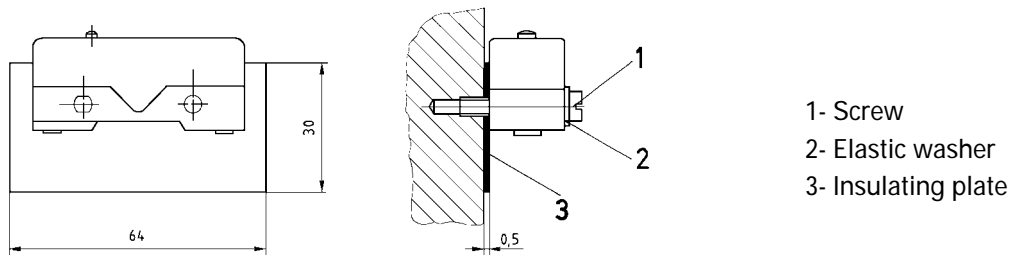

The tightening torque applied to the fixing screws must comply with the following:

Fixing screw	M3	M3.5
Tightening torque in Nm	0.5	0.8

## SERIES MP40 & DERIVATIVES

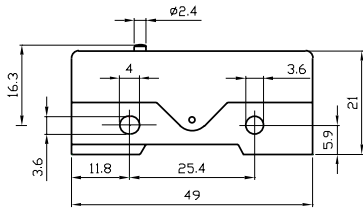
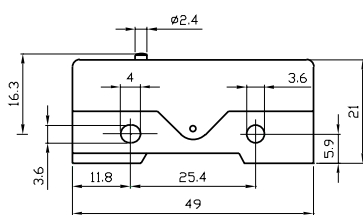
	DESIGNATION	ACTUATING FORCE $F_a$ max. (N)	RELEASE FORCE $F_r$ min (N)	FREE POSITION $P_r$ (mm)	OPERATING POSITION $P_a$ (mm)	OVER-TRAVEL $s_r$ min. (mm)	DIFFERENTIAL MOVEMENT $s_d$ max. (mm)
	<b>MP40-0</b> <b>MP50-0</b>	5,0	2,5	$16,3 \pm 0,5$	$15,9 \pm 0,3$	0,25	0,05
	<b>MP44-0</b>	1,5	0,6	$16,3 \pm 0,5$	$15,9 \pm 0,3$	0,25	0,05

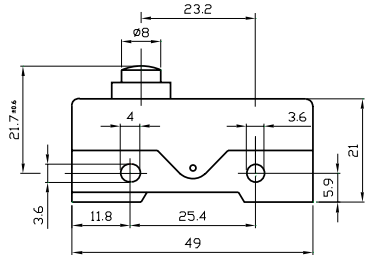
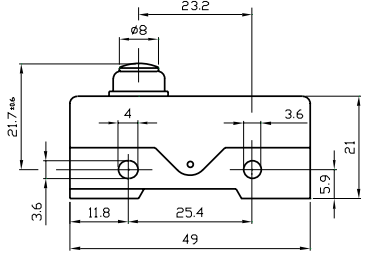

ACTUATING FORCE Fa max. (N)	RELEASE FORCE Fr min (N)	FREE POSITION Pr (mm)	OPERATING POSITION Pa (mm)	OVER-TRAVEL sr min. (mm)	DIFFERENTIAL MOVEMENT sd max. (mm)	DESIGNATION
5,0	2,0	21,7 ± 0,6	21,3 ± 0,3	1,2	0,06	<b>MP61-0</b>
5,0	2,0	21,7 ± 0,6	21,3 ± 0,3	1,2	0,02	<b>*MP61-1-0</b>
5,0	2,0	21,7 ± 0,6	21,3 ± 0,3	1,2	0,10	<b>**MP61-10-0</b>
						
5,0	2,0	21,7 ± 0,6	21,3 ± 0,3	1,0	0,06	<b>MP161-0</b>
5,0	2,0	21,7 ± 0,6	21,3 ± 0,3	1,0	0,02	<b>*MP161-1-0</b>
5,0	1,5	21,7 ± 0,6	21,3 ± 0,3	1,0	0,10	<b>**MP161-10-0</b>
						

\* **Reduced contact gap** – 0.20 to 0.25mm.  
 Designation «1» after series reference number.  
 Example: MP60-1-0, MP61-1-0.  
 Differential movement is between 0.01 and 0.02 mm (low hysteresis).  
 High repetitive switching precision.  
 Reduced switching rating: 110VAC - 15VA max.  
 48 VDC - 5W max.

\*\* **Increased contact gap**  
 Designation «-10» after series reference number.  
 Examples: MP60-10-0, MP161-10-0, MP161-10-0.  
 Differential travel is augmented (large hysteresis).

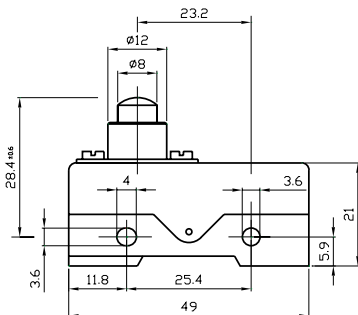
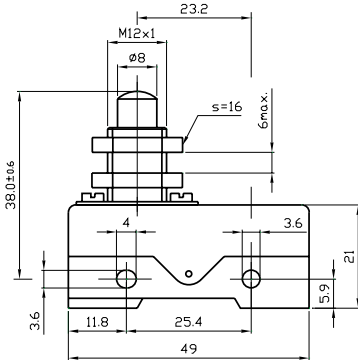
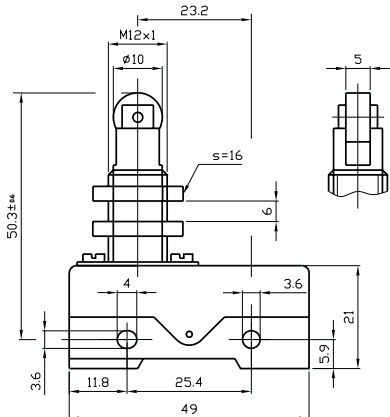
DESIGNATION	ACTUATING FORCE Fa max. (N)	RELEASE FORCE Fr min (N)	FREE POSITION Pr (mm)	OPERATING POSITION Pa (mm)	OVER-TRAVEL sr min. (mm)	DIFFERENTIAL MOVEMENT sd max. (mm)
	5,0	2,5	28,4 ± 0,6	27,9 ± 0,3	2,0	0,05
	5,0	2,5	38,0 ± 0,6	37,5 ± 0,3	5,0	0,05
	5,0	2,5	50,3 ± 0,6	49,8 ± 0,3	5,0	0,05

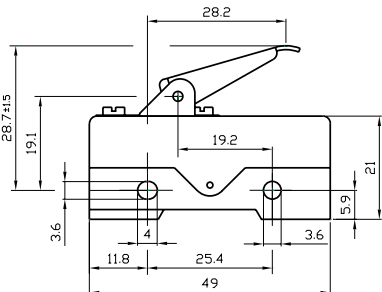
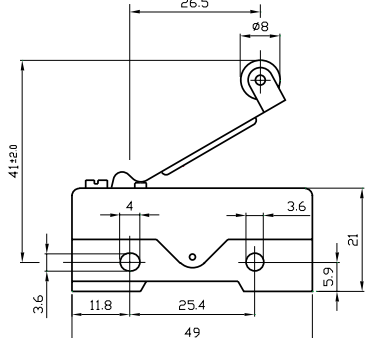
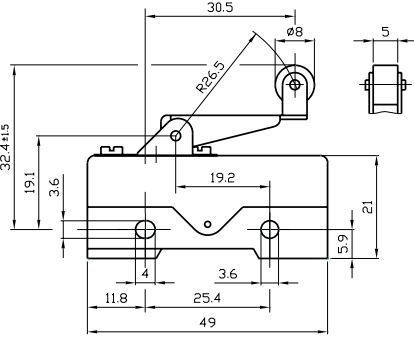
ACTUATING FORCE Fa max. (N)	RELEASE FORCE Fr min (N)	FREE POSITION Pr (mm)	OPERATING POSITION Pa (mm)	OVER-TRAVEL sr min. (mm)	DIFFERENTIAL MOVEMENT sd max. (mm)	DESIGNATION
4,5	1,5	28,7 ± 1,5	26,8 ± 1,5	3,5	0,50	<b>MP40-3A</b> 
2,5	0,7	41,0 ± 2,0	37,0 ± 2,0	2,0	0,80	<b>MP40-4AL</b> 
4,5	1,5	32,4 ± 1,5	30,0 ± 1,5	3,5	0,50	<b>MP40-5AL</b> 

# SERIES MP90 & DERIVATIVES

## MP90

### MICROSWITCHES

The microswitches MP90 & derivatives are snap-action changeovers, simple switching action, connection by screw lugs.

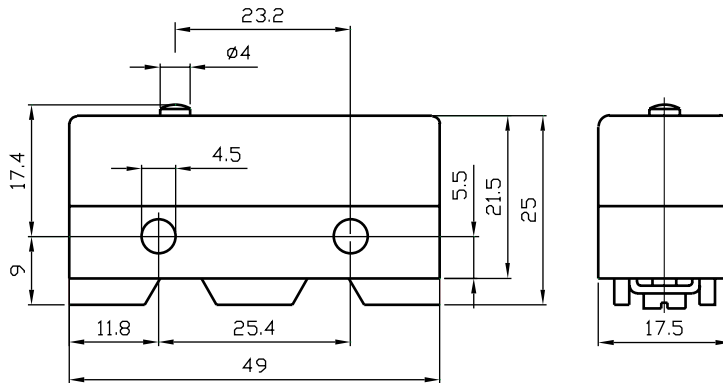

### GENERAL CHARACTERISTICS, MODELS MP90

Approval	: 
Switching rating	: 10A 400VAC
Degree of protection	: Housing IP67 Terminals IP00
Class of protection	: II
Micro-switching	: $\mu$
Distance between contacts	: 0,5 mm
Up to standard	: EN61058-1:92 + A1:93
Frequent functioning	: 50 E3
Mechanical life	: 50 x 10 <sup>6</sup> operations
Snap-action mechanism	: Beryllium coppers leaf spring with self-cleaning contacts
Actuators	: Overall dimensions in stainless steel
Dimensions	: DIN 41 635, ES-form

### SWITCHING DIAGRAM

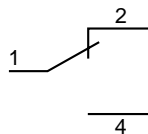

REFERENCE CODE OF THE ARTICLE

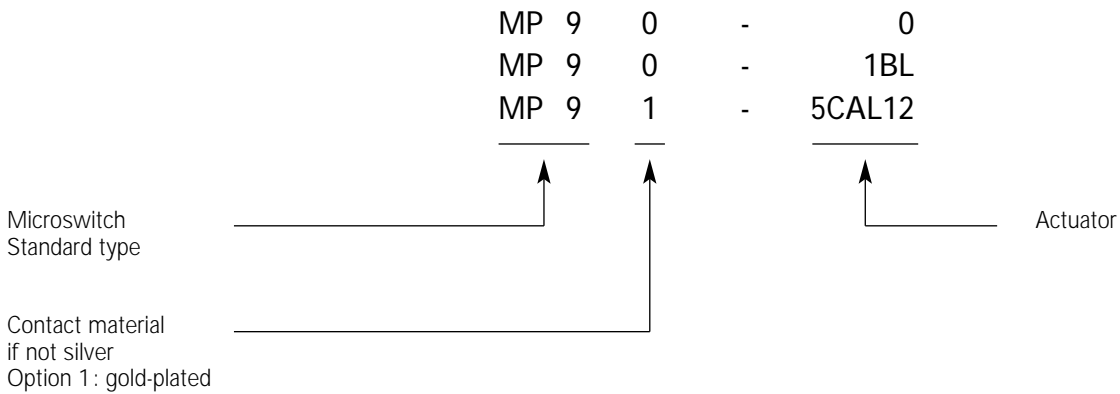

<b>Housing:</b>	PA6T/X reinforced with glass fibre Auto-extinguishing according to UL94V-O Certified temperature	- 40°C to + 130°C
<b>Membrane:</b>	Fluorsilicone rubber MFQ	- 40°C to + 175°C

**MP90 DEGREE OF PROTECTION**

This type is perfectly sealed: the switching mechanism is completely protected by the housing, which is itself assembled by ultrasonic welding. However, as it has protruding connection terminals which could come in contact with parts of the human body (IEC-529, 1st numeral), it is not eligible for an IP67 approval.

**LATERAL FIXING**

An **insulating plate** must be inserted between a microswitch with **protruding terminals** and **the fixing surface** if the surface is **metal**

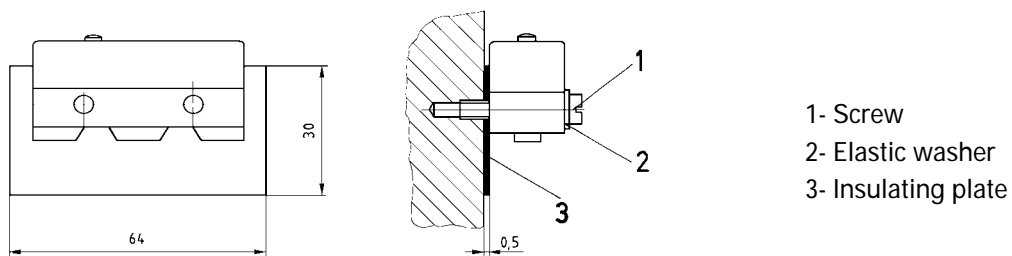

The tightening torque applied to the fixing screws must comply with the following:

Fixing screw	M3	M3.5	M4
Tightening torque in Nm	0.5	0.8	1.2

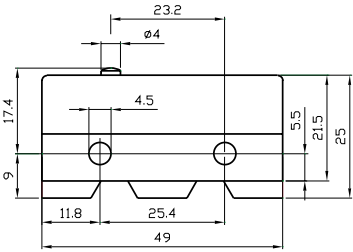
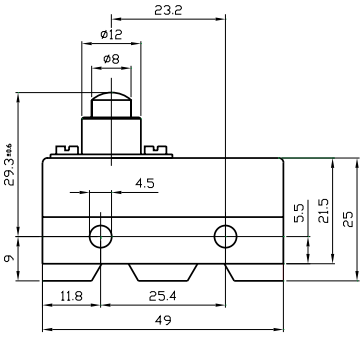
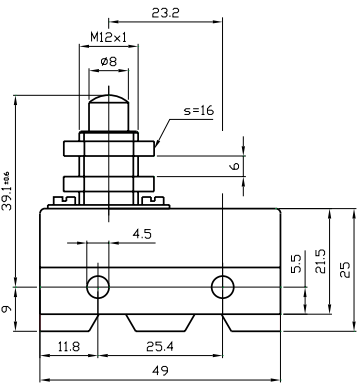
DESIGNATION	ACTUATING FORCE Fa max. (N)	RELEASE FORCE Fr min (N)	FREE POSITION Pr (mm)	OPERATING POSITION Pa (mm)	OVER-TRAVEL sr min. (mm)	DIFFERENTIAL MOVEMENT sd max. (mm)
	6,0	3,0	17,4 ± 0,5	16,7 ± 0,3	0,25	0,06
	6,0	3,0	29,3 ± 0,6	28,5 ± 0,3	2,0	0,08
	6,0	3,0	39,1 ± 0,6	38,4 ± 0,3	5,0	0,08

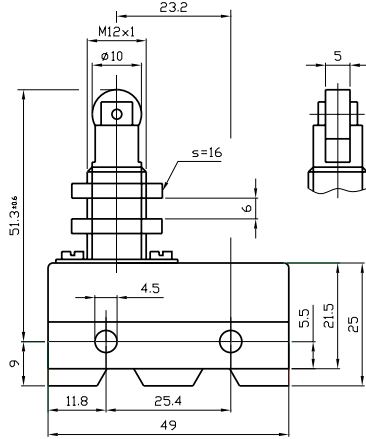
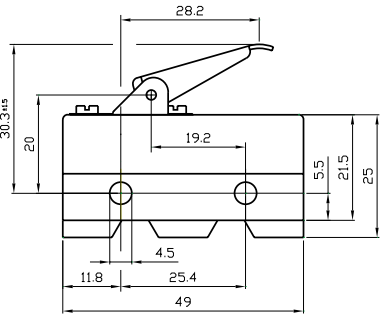
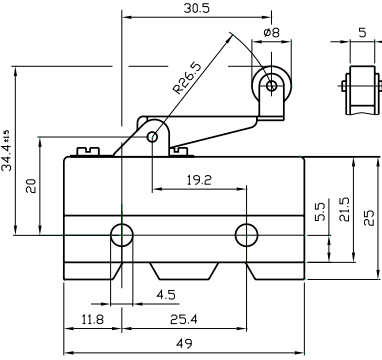
ACTUATING FORCE Fa max. (N)	RELEASE FORCE Fr min (N)	FREE POSITION Pr (mm)	OPERATING POSITION Pa (mm)	OVER-TRAVEL sr min. (mm)	DIFFERENTIAL MOVEMENT sd max. (mm)	DESIGNATION
6,0	3,0	51,3 ± 0,6	50,6 ± 0,3	5,0	0,08	<b>MP90-1BL</b> <b>MP90-1BLA</b> 
4,5	1,2	30,3 ± 1,5	28,5 ± 1,5	3,5	0,50	<b>MP90-3A</b> 
4,5	1,2	34,4 ± 1,5	31,9 ± 1,5	3,5	0,60	<b>MP90-5AL</b> 

# SERIES MP110 & DERIVATIVES

## MP110

### MICROSWITCHES

MP110 microswitches are snap-action changeovers, simple switching action.

Connections:

- Push-on clips 6.35 x 0.8mm
- Plug-in system of connection MP100-..
- Protective terminal covers MP110-Z..

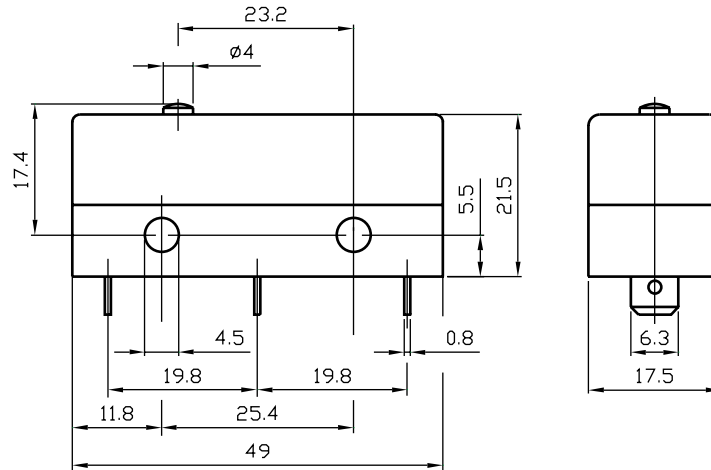

### GENERAL CHARACTERISTICS, MODELS MP110

Approval	: 
Switching rating	: 10A 400VAC
Degree of protection	
MP110-0	: Housing IP67 Terminals IP00
MP110-0 + MP100-..	: IP67
MP110-0 + MP110-Z..	: IP64
Class of protection	: II
Micro-switching	: $\mu$
Distance between contacts	: 0,5 mm
Up to standard	: EN61058-1:92 + A1:93
Frequent functioning	: 50 E3
Mechanical life	: 50 x 10 <sup>6</sup> operations
Snap-action mechanism	: Beryllium coppers leaf spring with self-cleaning contacts
Actuators	: Overall dimensions in stainless steel
Dimensions	: DIN 41 635, EF-form

### SWITCHING DIAGRAM

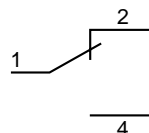

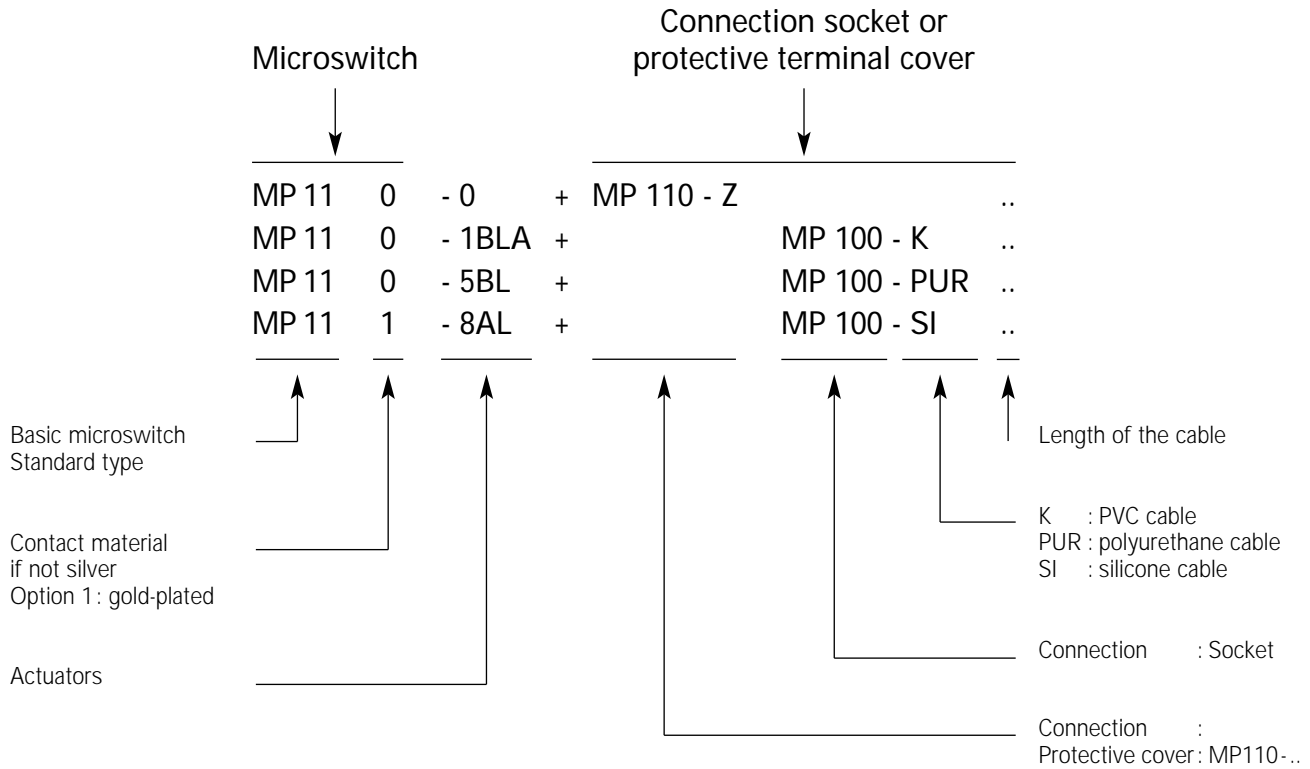

Housing:	PA6T/X reinforced with glass fibre Auto-extinguishing according to UL94V-O Certified temperature	- 40°C to + 130°C
Membrane:	Fluorsilicone rubber MFQ	- 40°C to + 175°C
Cable:	See page 15	

**MP110 DEGREE OF PROTECTION**

This type is completely sealed: the switching mechanism is completely protected by the housing, which is itself assembled by ultrasonic welding. However, as it has protruding connection terminals, it has to be provided with an accessory system of connection, which can be:

- Plug-in system of connection MP100-.. IP67
- Protective terminal covers MP110-Z.. IP64

# SERIES MP100 & DERIVATIVES

## MP100

### PLUG-ON CONNECTION SOCKET

The plug-on connection sockets MP100 and derivatives can be fixed on our MP110 and derivatives microswitches.

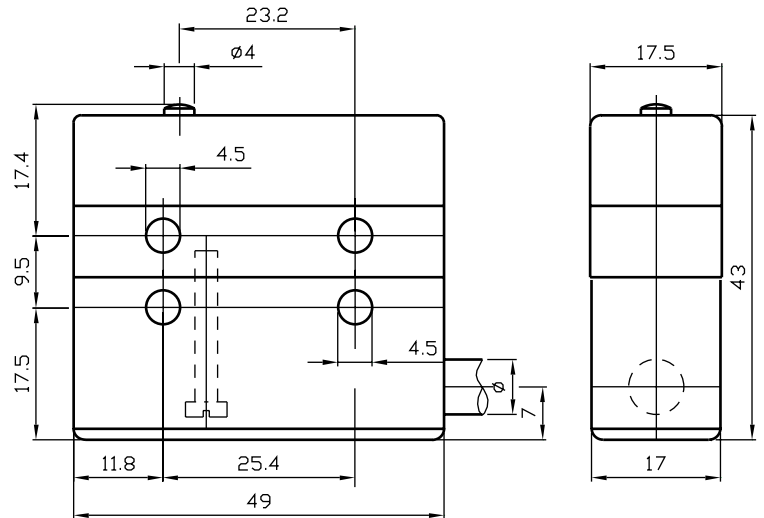
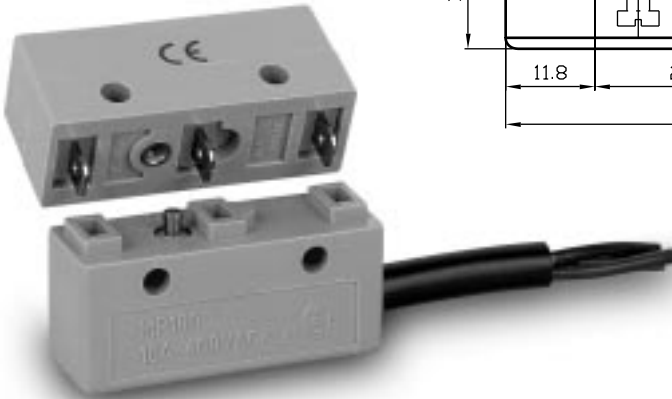

### TECHNICAL CHARACTERISTICS, TYPES MP100

The plug-on connection socket MP100-.. guarantees full protection, in accordance with degree-of-protection standard IP67, by means of a system of 3 sealing rings fitted into the microswitch. The assembly is held together and secured by means of an M3 screw housed in the socket unit. This unit is sealed.

Approval	: 
Degree of protection	: IP67
Connection	: Overmoulded cable

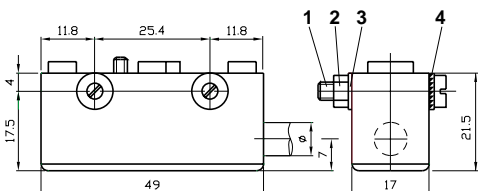
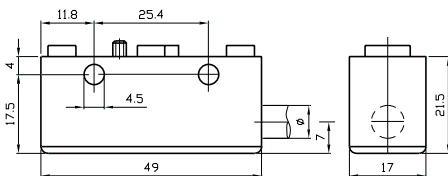

### MP100 or MP101 type fitting

The MP110+MP100-.. assembly can be mounted by the socket, which means that the socket can be fitted firstly and the switch inserted subsequently.

A spacing washer will have to be inserted to take up the difference in thickness between the switch (17.5mm) and the socket (17.0mm).

MP101-.. comprises the following fixing element:

- 1 - Fixing screw M4x25 – A2 stainless steel
- 2 - Nut M4
- 3 - Spacing washer s=0.8mm Ø4.3 mm
- 4 - Serrated locking washer Ø4.3mm

Moulding torque for = 1.2Nm

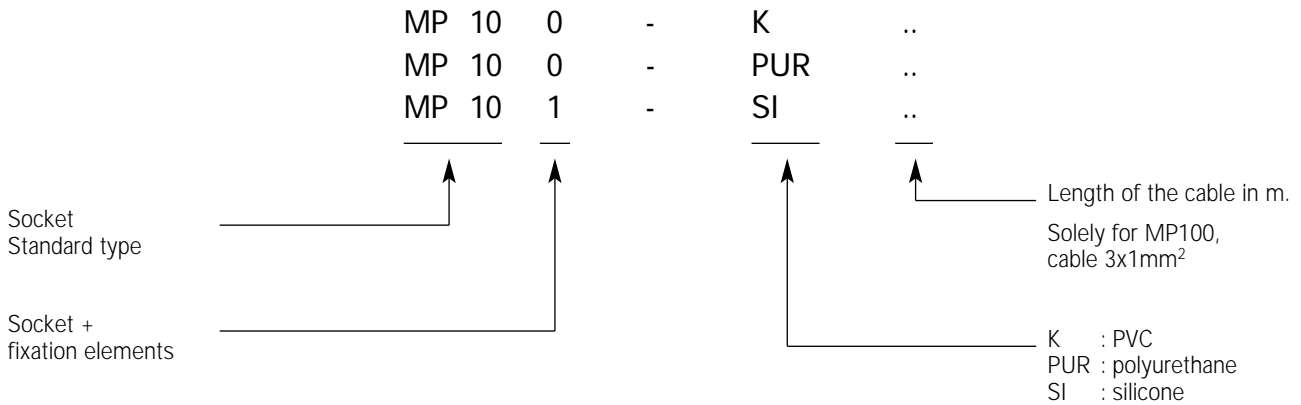

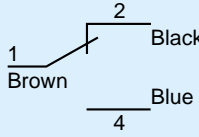
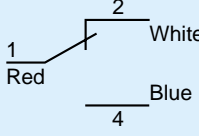
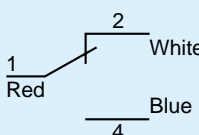
Designation	Switching diagram	Housing and connecting cable for MP100-.. socket
Housing:		PA6T/X reinforced with glass fibre Auto-extinguishing according to UL94V-O Certified operating temperatures: - 40°C to + 130°C
MP100-K..		PVC, 3x1.0 mm <sup>2</sup> , black coating External diameter: 7.3 mm Operating temperatures: - 20°C to + 70°C Thermoplastic synthetic material, standard for general use Good mechanical and electrical properties.
MP100-PUR..		PUR, 3x1.0 mm <sup>2</sup> , grey coating External diameter: 7.3 mm Operating temperatures: - 40°C to + 90°C High tear, crushes and puncture resistance. Good resistance to mineral oils Good flexibility even at low temperatures
MP100-SI..		SI, 3x1.0 mm <sup>2</sup> , white coating External diameter: 7.3 mm Operating temperatures: Mobile - 25°C to + 150°C Fixed - 40°C to + 150°C Max. in water + 100°C Synthetic silicone rubber. Excellent resistance to low and high temperatures. Ages well.
MP100- ?		We overmould with other types of cables as long as their characteristics are in accordance with the standards we apply to our products.

*According to the availability of the market we reserve ourselves the right to modify the colors of identification of wire connection.*

# SERIES MP110-Z.. & DERIVATIVES

## MP110-Z..

### PROTECTIVE TERMINAL COVER

The protective terminal covers and derivatives are fixed on our MP110 microswitches and derivatives.

They have 3 possible outlets, A, B or C as shown on the drawing below.

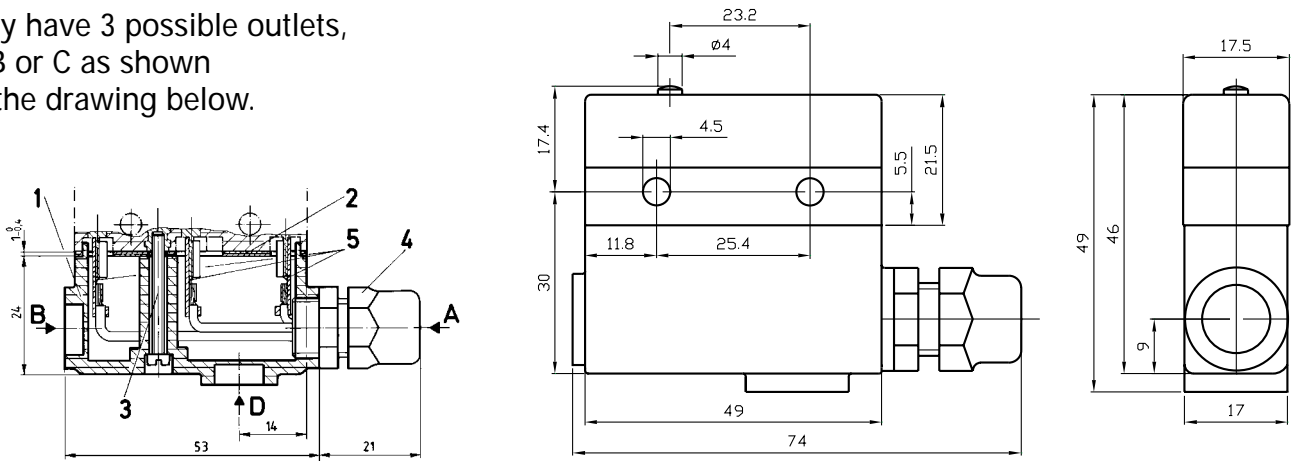

### TECHNICAL CHARACTERISTICS, TYPES MP110-Z..

The protective terminal covers MP110-Z.. (pos.1) can be used with any type of connecting cable. Fixed on a MP110, it guarantees a degree of protection in accordance with standard IP64. A sealing gasket, which is compressed between the switch MP110 and the terminal cover MP110-Z by tightening the fixing screw (pos.2), guarantees the tightness of the whole.

Approval	: 
Degree of protection	: IP64
Connection	: 3 – 6.35x0.8 mm push-on tags (pos.5) to rivet on the wires.

### DESIGNATION AND DESCRIPTION OF VARIANTS OF THE MP110-Z

Designation	Description
MP110-ZA or MP110-ZB or MP110-ZD	Only one outlet is tapped to take the PG7. The other two remain blocked.
MP110-ZA3 or MP110-ZB3 or MP110-ZD3	All three outlets are tapped to take the PG7. The MP110-Z is supplied with two sealing plugs for the unused outlets. The A, B or D indicates which outlet is open.
MP110-ZAPG7 or MP110-ZBPG7 or MP110-ZDPG7	According to the designation, only one outlet is fitted with a PG7. The others remain blocked.
MP110-ZA3PG7 or MP110-ZB3PG7 or MP110-ZD3PG7	All three outlets are tapped to take the PG7. According to the designation, one is fitted with a PG7, the other two with sealing plugs.

Housing:	PA6T/X reinforced with glass fibre Auto-extinguishing according to UL94V-O Certified temperature	- 40°C to + 130°C
Sealing gasket:	Silicone (SI)	- 40°C to + 150°C
PG7 stuffing box: (cable gland)	Polyamide with glass fibre	- 20°C to + 100°C

SWITCHING CHARACTERISTICS OF THE MP110 AND DERIVATIVES

ACTUATING FORCE Fa max. (N)	RELEASE FORCE Fr min (N)	FREE POSITION Pr (mm)	OPERATING POSITION Pa (mm)	OVER-TRAVEL sr min. (mm)	DIFFERENTIAL MOVEMENT sd max. (mm)	DESIGNATION
6,0	3,0	17,4 ± 0,5	16,6 ± 0,3	0,25	0,06	<b>MP110-0</b>
6,0	3,0	17,4 ± 0,5	16,8 ± 0,3	0,25	0,02	<b>*MP120-1-0</b>
6,0	2,5	17,4 ± 0,5	16,7 ± 0,3	0,25	0,10	<b>**MP120-10-0</b>
6,0	3,0	29,3 ± 0,6	28,5 ± 0,3	2,0	0,08	<b>MP110-1S29</b>

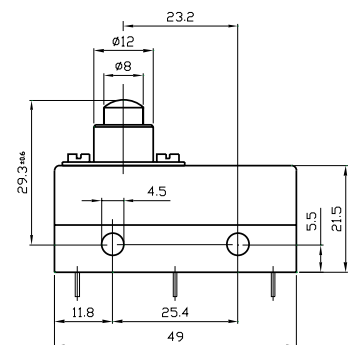
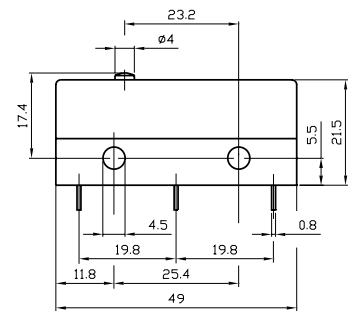

\* **Reduced contact gap** – 0.20 to 0.25mm.  
Designation «1» after series reference number.  
Example: MP120, MP120-1-0.  
Differential movement is between 0.01 and 0.02 mm (low hysteresis).  
High repetitive switching precision.  
Reduced switching rating: 110VAC - 15VA max.  
48 VDC - 5W max.

\*\* **Increased contact gap**  
Designation «-10» after series reference number.  
Examples: MP120-10-0.  
Differential travel is augmented (large hysteresis).

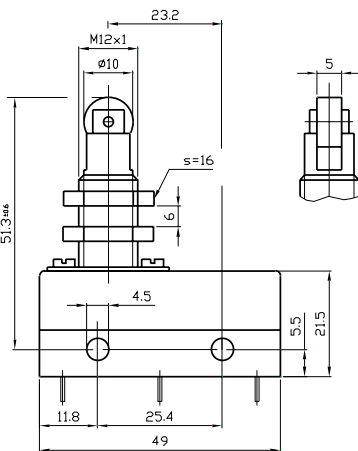
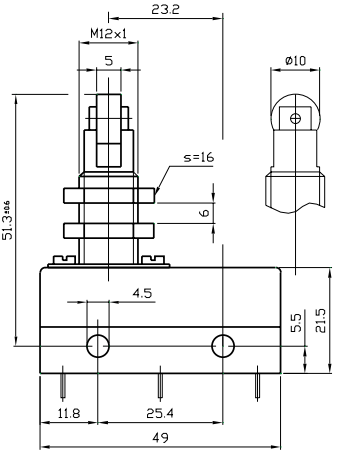
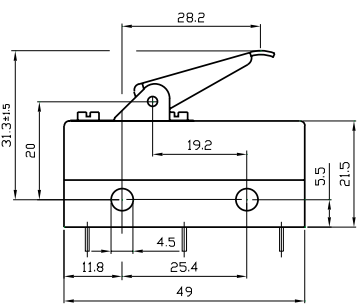

ACTUATING FORCE Fa max. (N)	RELEASE FORCE Fr min (N)	FREE POSITION Pr (mm)	OPERATING POSITION Pa (mm)	OVER-TRAVEL sr min. (mm)	DIFFERENTIAL MOVEMENT sd max. (mm)	DESIGNATION
6,0	3,0	51,3 ± 0,6	50,6 ± 0,3	5,0	0,08	MP110-1BL
6,0	3,0	51,3 ± 0,6	50,6 ± 0,3	5,0	0,08	MP110-1BLA
						
6,0	3,0	51,3 ± 0,6	50,6 ± 0,3	5,0	0,08	MP110-1BT
6,0	3,0	51,3 ± 0,6	50,6 ± 0,3	5,0	0,08	MP110-1BTA
						
4,5	1,2	31,3 ± 1,5	29,3 ± 1,5	3,5	0,50	MP110-3A
						

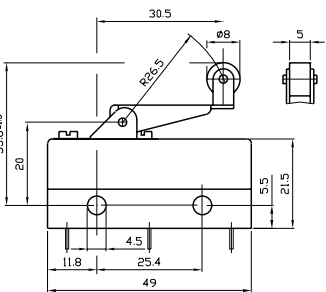
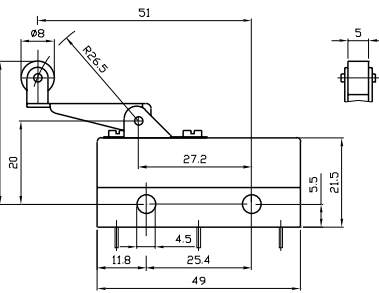
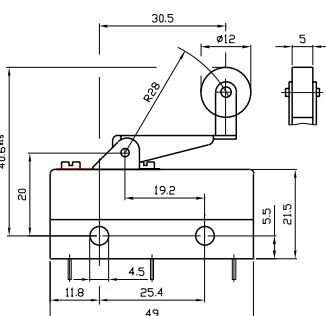
DESIGNATION	ACTUATING FORCE Fa max. (N)	RELEASE FORCE Fr min (N)	FREE POSITION Pr (mm)	OPERATING POSITION Pa (mm)	OVER-TRAVEL sr min. (mm)	DIFFERENTIAL MOVEMENT sd max. (mm)
	4,5	1,2	35,8 ± 1,5	33,0 ± 1,5	3,5	0,60
	4,5	1,2	35,8 ± 1,5	33,0 ± 1,5	3,5	0,60
	4,5	1,2	40,6 ± 1,5	37,8 ± 1,5	3,5	0,60



# SERIES MP210 & DERIVATIVES

## MP210

### MICROSWITCHES

#### IP67 & IP68

The microswitches MP210 & derivatives are snap-action changeovers, simple or double switching action, connection by directly overmoulded cable. By wiring the 5 terminals in different combinations, you can obtain electrical circuits to 3, 4 or 5 wires.

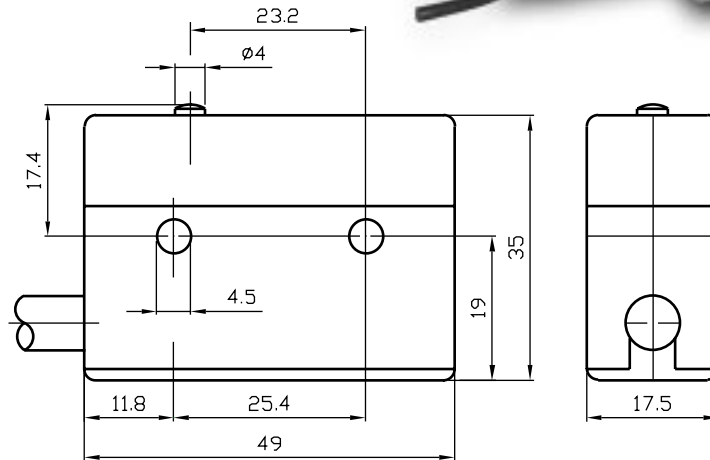

### GENERAL CHARACTERISTICS, MP210 TYPES

Approval,	:  , 10A (2 x 5) 250VAC
switching rates	: <b>CSA</b> , 6A 250VAC, 0,5A 125VDC, 0,25A 250VDC
Degree of protection, MP210	: IP67
MP215	: IP68
Class of protection	: II
Micro-switching	: $\mu$
Contact-gap	: 0,8 mm
Up to standard	: EN61058-1:92 + A1:93
Frequent functioning	: 50 E3
Mechanical life	: 50 x 10 <sup>6</sup> operations
Snap-action mechanism	: Beryllium coppers leaf spring with self-cleaning contacts
Actuators	: Overall dimensions in stainless steel
Dimensions	: DIN 41 635, E-form

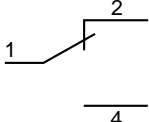
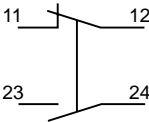
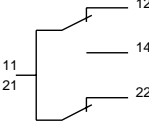
<p><b>CHANGEOVER</b></p> <p>The fixed contact terminals are wired in parallel when the cable is connected. The two closed contacts (12) and (22), on the one hand, and the two open contacts (14) and (24), on the other, form a changeover with terminal (1) in common. this arrangement of parallel contacts doubles the reliability of the switch</p>	<p>Designation: <b>MP210-0/3..</b></p> 
<p><b>OFF-ON CIRCUIT</b></p> <p>Here, the common terminal is not wired producing two separate circuits with no common terminal. The strip merely switches between the fixed contacts. This variant is recommended for heavy loads because of the simultaneous opening of a double contact gap.</p>	<p>Designation: <b>MP210-0/4..</b></p> 
<p><b>GENERAL CIRCUIT</b></p> <p>In this version, the overmoulded cable is wired to all of the connecting terminals thus allowing for all possibilities which makes it particularly suitable for prototype development and testing purposes. However, the cable is more rigid and the diameter approaching 9.0mm.</p>	<p>Designation: <b>MP210-0/5..</b></p> 

# REFERENCE CODE OF THE ARTICLE

# SERIES MP210 & DERIVATIVES

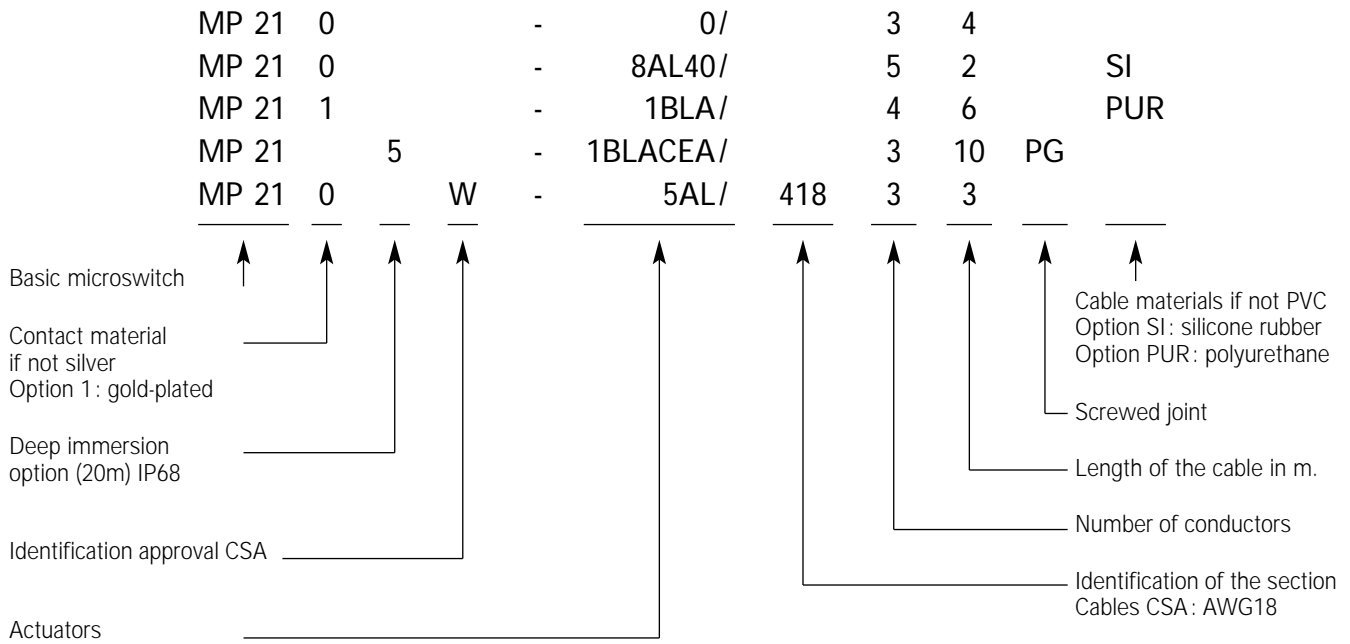

<b>Housing:</b>	PA6T/X reinforced with glass fibre Auto-extinguishing according to UL94V-O Certified temperature	- 40°C to + 130°C
<b>Membrane:</b>	Fluorsilicone rubber MFO	- 40°C to + 175°C
<b>Cable:</b>	PVC <b>SI</b> Silicone rubber <b>PUR</b> polyurethane rubber	- 20°C to + 70°C - 40°C to + 150°C - 40°C to + 90°C

## DESCRIPTION AND MICROSWITCHES SWITCHING DIAGRAMS, SERIES MP210

DESIGNATION OF CONNECTION CABLES	POLYVINYLE CHLORID (PVC)	POLYURETHANE Designation : PUR	SILICONE Designation : SI
<b>Designation</b>	<b>MP210-0/3..</b>	<b>MP210-0/3..PUR</b>	<b>MP210-0/3..SI</b>
<b>Changeover</b>			
<b>Designation</b>	<b>MP210-0/4..</b>	<b>MP210-0/4..PUR</b>	<b>MP210-0/4..SI</b>
<b>OFF-ON Switch</b>			
<b>Designation</b>	<b>MP210-0/5.. or -0/5..PUR</b>		
<b>General Circuit</b> Coloured Leads or Numbered Leads			
	<p><i>According to the availability of the market we reserve ourselves the right to modify the colors of identification of wire connection.</i></p>		

# MP210 MICROSWITCH – REVERSE CABLE OUTLET

Designation «S»

DESIGNATION: MP210-0/...S

The cable outlet on the MP210 series of microswitches is reversed as compared to that on the MP110-0 + MP100 socket assembly. In order that the two units may be interchangeable, the dimension of the microswitch fixing holes being the same, the cable outlet can be reversed in the MP210 series.

This variation can be effected only with the following models:

- MP210-0/3.. Changeover switch becomes : MP210-0/3..S
- MP210-0/4.. Off-On switch becomes : MP210-0/4..S

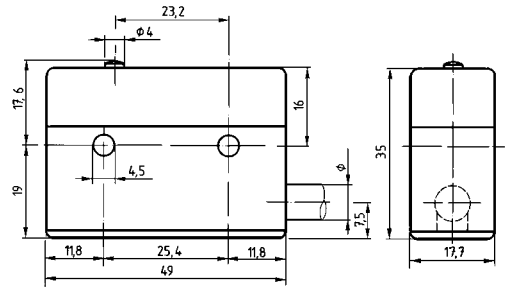

## MP210 SERIES SEALED MICROSWITCH + STUFFING BOX (CABLE GLAND)

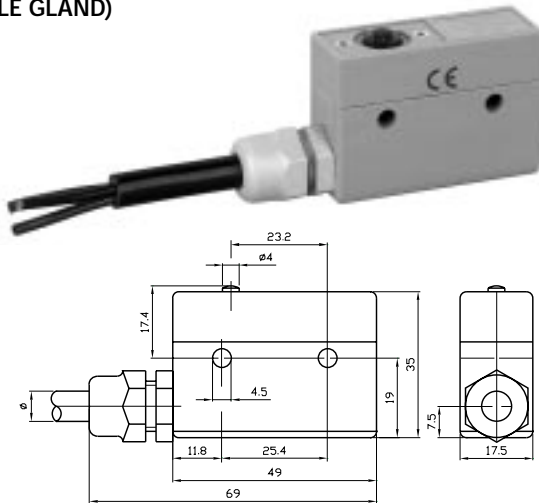

MP210-0/.. PG

For severe operating conditions, when the length of cables used is considerable and the cable is subject to tugging and twisting strains where it leaves the switching housing, we recommend that the switch outlet be fitted with a stuffing box (cable gland). In certain environments (such as attack by chemical agents) where the diameter of the cable may alter, this ensures a constant degree of protection.

**STUFFING BOX:** Type PG7  
 (CABLE GLAND) Glass-fibre reinforced Polyamide, light grey  
 Washer of Perbunan N.  
 Temperature: -20°C to + 80°C

This variant is not possible for cables with a diameter in less of 7.5mm.

## MP210 SERIES SEALED MICROSWITCH APPROVAL CSA

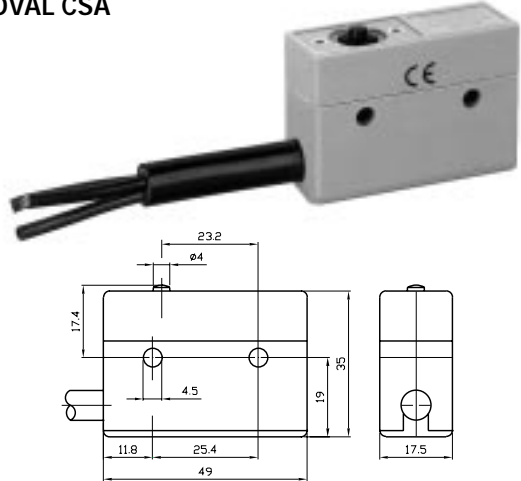

MP210W-0/418/3..

A variant on the standard model overmoulded with a connection cable according to CSA standard. Thus, the whole could be approved according to CSA standard of which we have the certificate at disposal.

The dimension is identical and the MP210W-0/418/3.. can receive the complete range of our actuators.

DESCRIPTION DESIGNATION	SWITCHING DIAGRAM	DESCRIPTION DESIGNATION	SWITCHING DIAGRAM
MP210-0/3.PG  For use with standard 3x1mm <sup>2</sup> cables. Switching rating: 10 A 250 VAC		MP210W-0/418/3..  Connecting cable sheath neoprene black, type SJOW conductors AWG18  Switching rating: 6 A 250 VAC  Temperatures -40°C to +90°C	<p>The green conductor is not used</p>
MP210-0/475/4.. PG  For use with standard 4x0.75 mm <sup>2</sup> cables. Switching rating: 6 A 250 VAC		Command characteristics opposite, page 25	

# CHARACTERISTICS OF COMMAND SERIES MP210 – MICROSWITCH MP215 CONTINUOUS IMMERSION IP68

## GENERAL CHARACTERISTICS

We can supply a microswitch of the same dimensions as the MP210-0/3.PG that is a variant thereon and which requires an increased actuating force making it suitable for operation under several meters of liquid – generally water. The reason for this increased force is that, at a certain depth, the pressure of the water on the membrane can cause a switch with a normal actuating force to operate automatically.

- Approvals : 
- Switching rating : 10A (2x5) 250VAC
- Mechanical life : 10 x 10<sup>6</sup> operations
- Connection : Over-moulded cable with PG7 stuffing box (cable gland).  
Does not exist for general circuit, 5 leads.
- Degree of protection : **IP68**  
Maximum immersion depth of **20 m in water**.
- Actuators : Use only telescopic plungers.  
**ATTENTION**: modified internal mechanism – Code **CEA**  
Amended designation: **1BLACEA, 1ACEA**

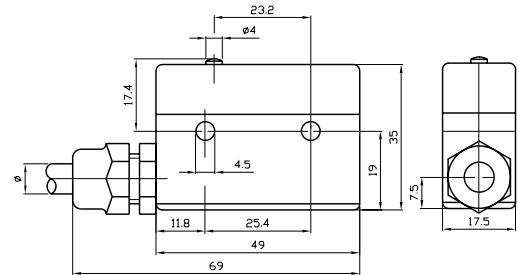

MP215-0/3.PG

ACTUATING FORCE Fa max. (N)	RELEASE FORCE Fr min (N)	FREE POSITION Pr (mm)	OPERATING POSITION Pa (mm)	OVER-TRAVEL sr min. (mm)	DIFFERENTIAL MOVEMENT sd max. (mm)	DESIGNATION
12,5	6,0	51,4 ± 0,6	50,4 ± 0,3	5,0	0,12	MP215-1BLACEA/..PG
12,5	6,0	17,4 ± 0,5	16,5 ± 0,3	0,25	0,10	MP215-0/..
6,0	2,5	17,4 ± 0,5	16,5 ± 0,3	0,25	0,10	MP210W-0/418/3..
6,0	2,2	17,4 ± 0,5	16,5 ± 0,3	0,25	0,10	MP210-0/..

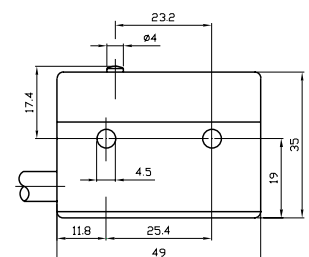
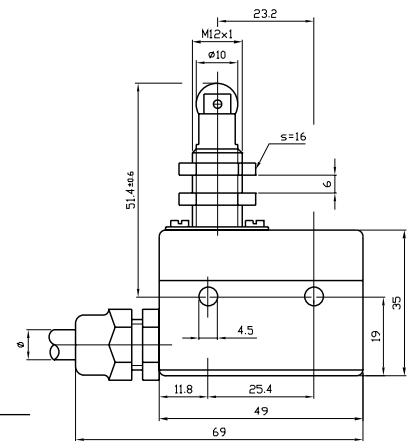

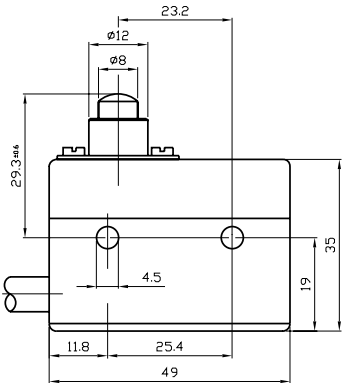
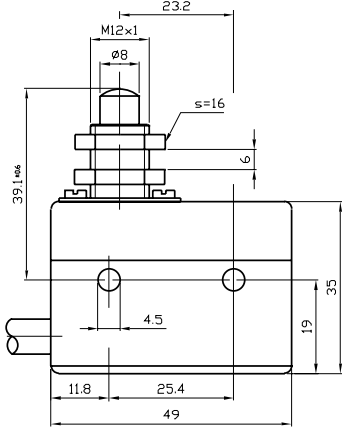
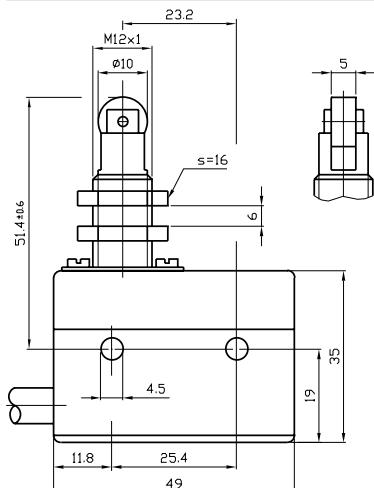
DESIGNATION	ACTUATING FORCE Fa max. (N)	RELEASE FORCE Fr min (N)	FREE POSITION Pr (mm)	OPERATING POSITION Pa (mm)	OVER-TRAVEL sr min. (mm)	DIFFERENTIAL MOVEMENT sd max. (mm)
 <p><b>MP210-1S29/..</b></p>	6,0	2,5	29,3 ± 0,6	28,4 ± 0,3	2,0	0,12
 <p><b>MP210-1A/..</b></p>	6,0	2,5	39,1 ± 0,6	38,3 ± 0,3	5,0	0,12
 <p><b>MP210-1BL/..</b></p>	6,0	2,5	51,4 ± 0,6	50,7 ± 0,3	5,0	0,12

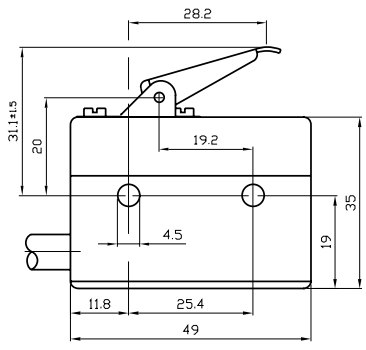
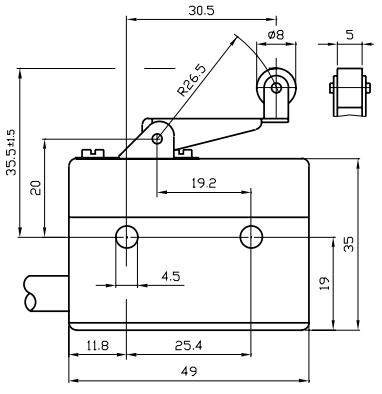
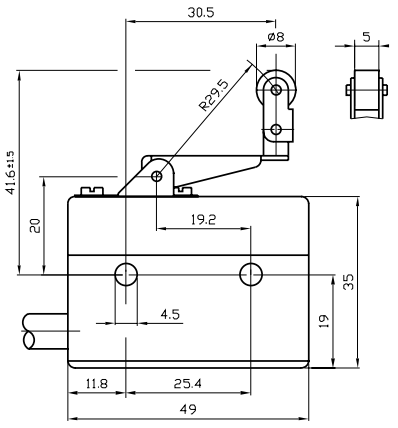
ACTUATING FORCE Fa max. (N)	RELEASE FORCE Fr min (N)	FREE POSITION Pr (mm)	OPERATING POSITION Pa (mm)	OVER-TRAVEL sr min. (mm)	DIFFERENTIAL MOVEMENT sd max. (mm)	DESIGNATION
4,5	1,2	31,1 ± 1,5	29,0 ± 1,5	3,5	0,80	MP210-3A/.. 
4,5	1,2	35,5 ± 1,5	32,5 ± 1,5	3,5	0,90	MP210-5AL/.. 
4,5	1,2	41,6 ± 1,5	38,6 ± 1,5	3,5	0,90	MP210-6AL/.. 

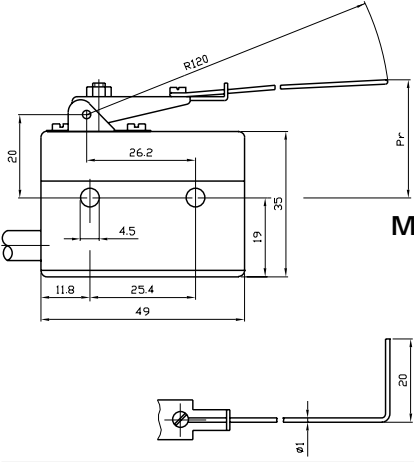
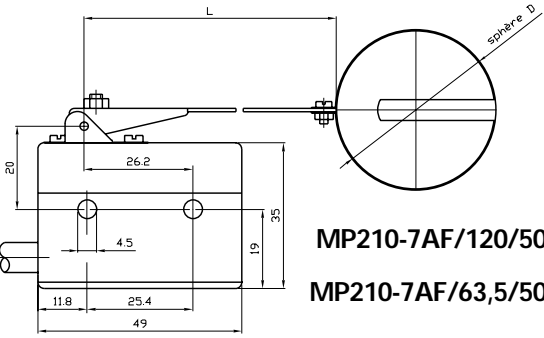
DESIGNATION	ACTUATING FORCE Fa max. (N)	RELEASE FORCE Fr min (N)	FREE POSITION Pr (mm)	OPERATING POSITION Pa (mm)	OVER-TRAVEL sr min. (mm)	DIFFERENTIAL MOVEMENT sd max. (mm)
 <p><b>MP210-7C/..</b></p>	0,2	0,05	-	-	-	5,00
 <p><b>MP210-7AF/120/50/..</b> <b>MP210-7AF/63,5/50/..</b></p>	-	-	-	-	-	4,00 2,00

### ACTUATORS, SERIES 7F – LEVER WITH FLOAT

In this variant, a polypropylene float is mounted in an 18/8 stainless spring steel harness fixed to the end of lever 7.

The assembly is used lever downwards which means that it releases the actuator button of the microswitch by means of its own weight and can thus be used to control the lever of a liquid, to ensure safety of a filling process or to give an alarm in case of overflow.

Adapting the length of the lever or the diameter of the float can vary the sensitivity of the assembly. Regulating the screw on the lever arm can set the final level.

Designation: 7F/63.5/50  
7F/120/50

Temperature max. : 100°C

ACTUATING FORCE Fa max. (N)	RELEASE FORCE Fr min (N)	FREE POSITION Pr (mm)	OPERATING POSITION Pa (mm)	OVER-TRAVEL sr min. (mm)	DIFFERENTIAL MOVEMENT sd max. (mm)	DESIGNATION
0.2	0,05	-	-	-	4,00	<b>MP210-8AL120/..</b>
0.4	0,1	-	-	-	2,00	<b>MP210-8AL63,5/..</b>
0.6	0,2	-	-	-	1,20	<b>MP210-8AL40/..</b>
0.6	0,2	47,5 ± 2,0	-	-	2,00	<b>MP210-8CAL12/..</b>

### ACTUATOR SERIES 8C

Identical to actuators of series 8 except that in this case they are fitted with a diam. 12mm roller and a return spring in the actuator arm the radius of which is set at 65mm. Being of a «U» cross-section, this lever is more rigid over this length than the 8AL 63.5mm. The actuator can be supplied with the following types of roller :

	Designations
Standard	8CL12, 8CT12
Designation «A»	8CLA12, 8CTA12
Designation «BZ»	8CLBZ12

In the case of variants «A» and «BZ», the weight of the roller must be taken into account in calculating switching speed and frequency. The roller must be eased back to the free position to avoid bounce.

# SERIES MP320 & DERIVATIVES

## MP320

### SEALED MINIATURE MICROSWITCH IP67

The MP320 miniature microswitch is a snap-action changeover simple break with the connection cable directly over-moulded into the housing.

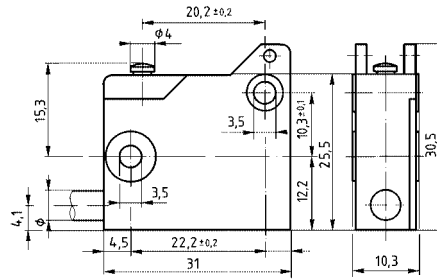

#### GENERAL CHARACTERISTICS, TYPE MP320

Approvals	: 
depending on the version	: CSA
Degree of protection	: IP67
Class of protection	: II
Micro-switch	: $\mu$
Contact-gap	: 0.8 mm
Standards	: EN61058-1:92 + A1:93
Frequent functioning	: 50 E3
Mechanical life	: 50 x 10 <sup>6</sup> operations
Snap-action mechanism	: Beryllium coppers leaf spring with self-cleaning contact.
Actuators	: Overall dimensions in stainless steel.
Dimensions	: DIN 41 635, form A

#### SWITCHING CAPACITY

Depending on the material of the electrical contacts and the cross-section of conductors.

Approvals			CSA
Cross-section of conductors	0.75 mm <sup>2</sup>	0.50 mm <sup>2</sup>	AWG 18
Ag contacts	6A 250VAC	2A 250VAC	6A 250VAC
Gold-plated contacts	0,1A 24VAC/DC		

**REFERENCE CODE OF THE ARTICLE**

**SERIES MP320 & DERIVATIVES**

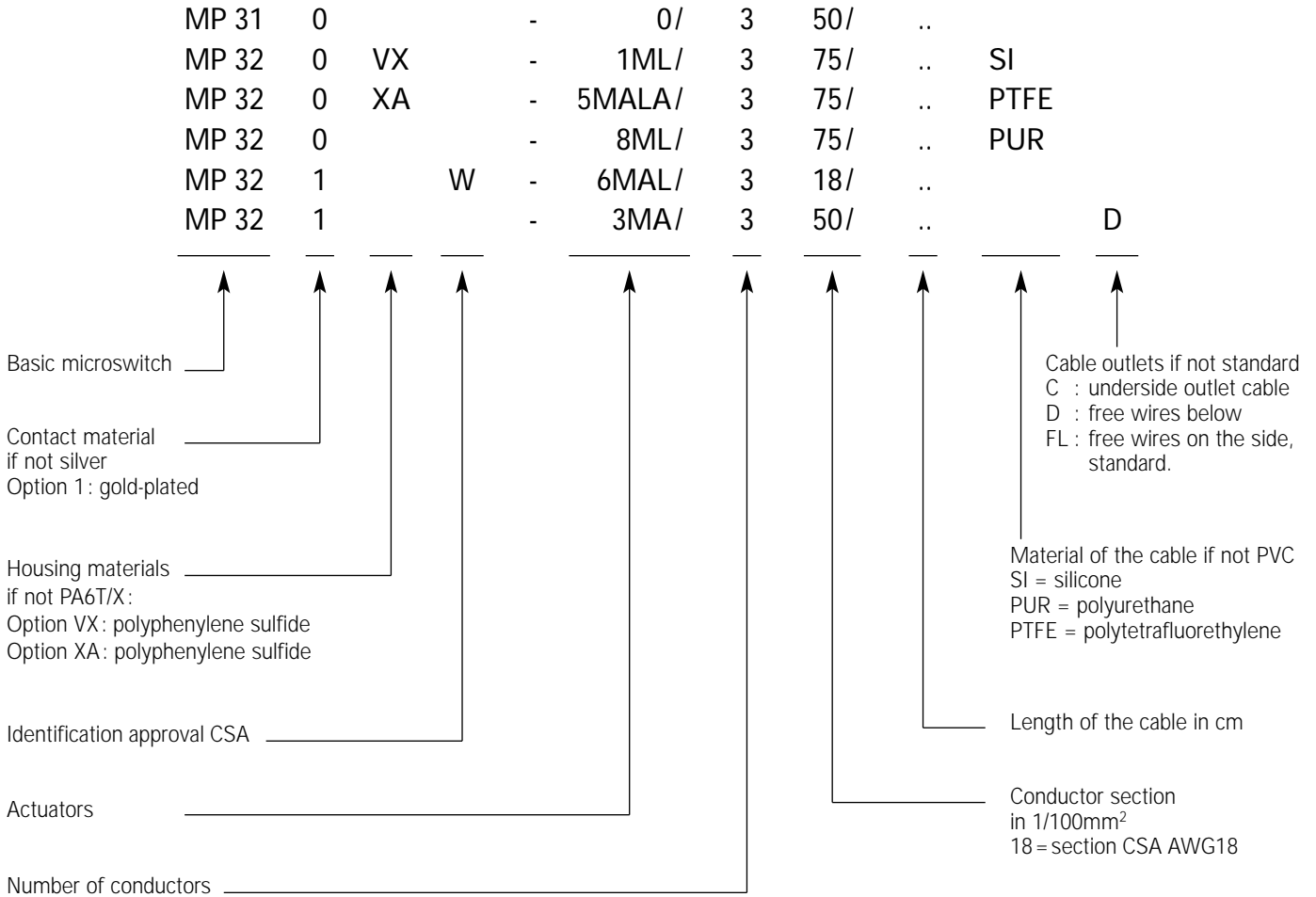

Housing:	PA6T/X reinforced with glass fibre	- 40°C to + 130°C
	Auto-extinguishing according to UL94V-O	- 40°C to + 130°C
	VX PPS reinforced with glass fibre	- 40°C to + 150°C
	Auto-extinguishing according to UL94V-O	- 40°C to + 150°C
Membrane:	XA PPS reinforced with glass fibre	- 40°C to + 200°C
	Auto-extinguishing according to UL94V-O	- 40°C to + 200°C
	Certified temperature	
Cable:	Fluorsilicone rubber MFQ	- 40°C to + 175°C
	Variant XA (Membrane SI)	- 40°C to + 200°C
	PVC	- 20°C to + 70°C
	SI Silicone rubber	- 40°C to + 150°C
Free wires:	PUR polyurethane rubber	- 40°C to + 90°C
	PTFE polytetrafluorethylene	- 40°C to + 200°C
	PVC-CSA TR64 AWG18	- 40°C to + 105°C
	RXL155, outlets D or FL (without identification)	- 55°C to + 155°C

**CONNECTION**

By cables or supple wires

**Cable with standard outlet**



Examples :

- MP320-0/375/100SI
- MP320-0/375/200
- MP320-5MAL/375/100PUR
- MP321-6MAL/375/80
- MP320VX-5MALA/375/500SI
- MP320XA-1ML/375/100PTFE

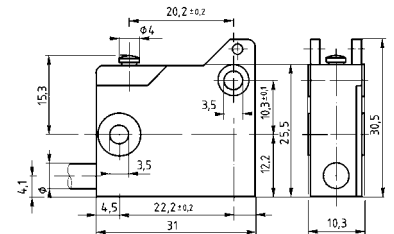

**Underside cable outlet «C»**



Examples :

- MP320-1MS27/375/50PURC
- MP320-3MB/375/200C

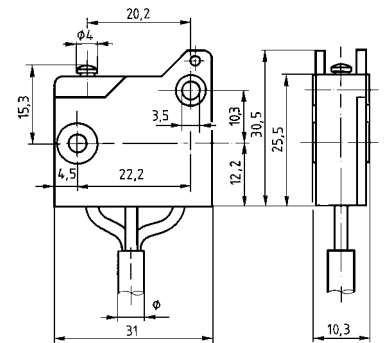

**Independent wire connection,  
underside outlet «D»  
Independent wire connection,  
approval CSA**



Examples :

- MP320-0/375/50D
- MP320-1MPSI/375/100D
- MP320W-5MAL/318/50D

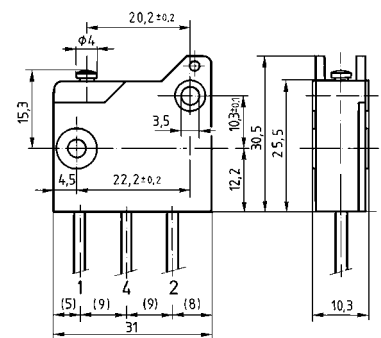

**WIRING DIAGRAM**

In relation with the type of the cable, the independent wires and the actuators

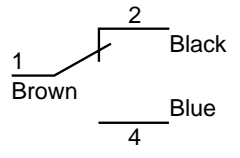
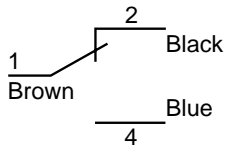
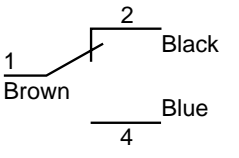
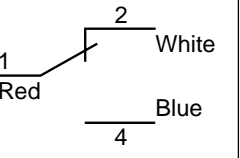
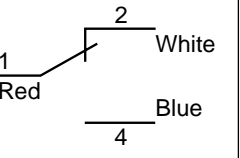
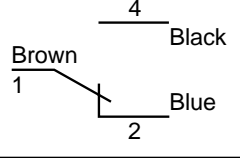
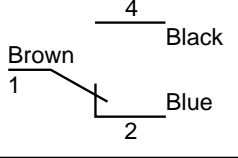
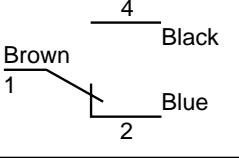
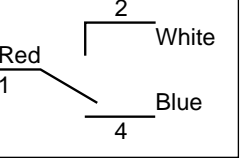
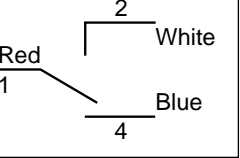
Isolating materials	PVC & RXL155	PTFE	Polyurethane	Silicone	CSA-PVC
Code in the reference of the article		<b>PTFE</b>	<b>PUR</b>	<b>SI</b>	<b>../318/..</b>
Without actuator «0» or type 1M..., 7M..., 8M...					
Reverse levers, types 3M..., 5M..., 6M...					

According to the availability of the market we reserve ourselves the right to modify the colors of identification of wire connection.

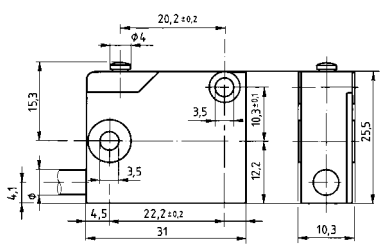
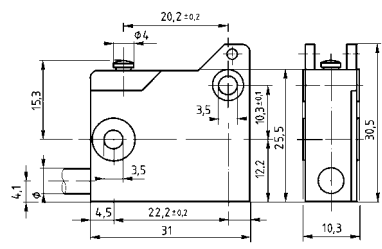
ACTUATING FORCE Fa max. (N)	RELEASE FORCE Fr min (N)	FREE POSITION Pr (mm)	OPERATING POSITION Pa (mm)	OVER-TRAVEL sr min. (mm)	DIFFERENTIAL MOVEMENT sd max. (mm)	DESIGNATION
3,5	1,0	15,3 ± 0,3	14,7 ± 0,2	0,2	0,07	MP310-0/..
						
3,5	1,0	15,3 ± 0,3	14,7 ± 0,2	0,2	0,07	MP320-0/..
						

\* **1MPN**: Chloroprene protective sleeve  
 \*\* **1MPSI**: Silicone protective sleeve

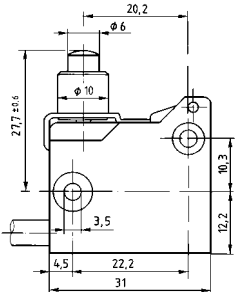
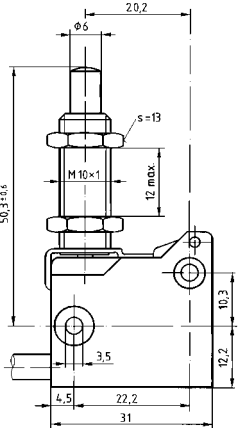
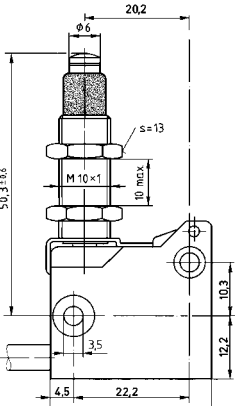
DESIGNATION	ACTUATING FORCE Fa max. (N)	RELEASE FORCE Fr min (N)	FREE POSITION Pr (mm)	OPERATING POSITION Pa (mm)	OVER-TRAVEL sr min. (mm)	DIFFERENTIAL MOVEMENT sd max. (mm)
 <p><b>MP320-1MS27/..</b></p>	3,5	1,0	27,7 ± 0,6	27,2 ± 0,3	2,0	0,10
 <p><b>MP320-1M/..</b></p>	3,5	1,0	50,3 ± 0,6	49,7 ± 0,3	5,0	0,10
 <p>* <b>MP320-1MPN/..</b>                  ** <b>MP320-1MPSI/..</b></p>	4,0	1,0	50,3 ± 0,6	49,7 ± 0,3	3,0	0,10

ACTUATING FORCE Fa max. (N)	RELEASE FORCE Fr min (N)	FREE POSITION Pr (mm)	OPERATING POSITION Pa (mm)	OVER-TRAVEL sr min. (mm)	DIFFERENTIAL MOVEMENT sd max. (mm)	DESIGNATION
3,5	1,0	49,8 ± 0,6	49,3 ± 0,3	5,0	0,10	MP320-1ML/..
3,5	1,0	49,8 ± 0,6	49,3 ± 0,3	5,0	0,10	MP320-1MT/..
2,5	1,0	26,0 ± 1,0	24,2 ± 0,6	2,5	0,80	MP320-3MA/..
2,5	1,0	26,0 ± 1,0	24,2 ± 0,6	2,5	0,80	MP320-3MB/..

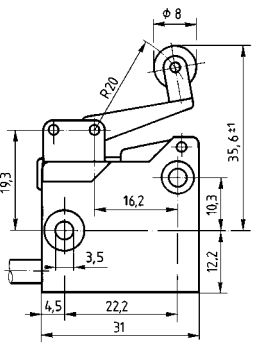
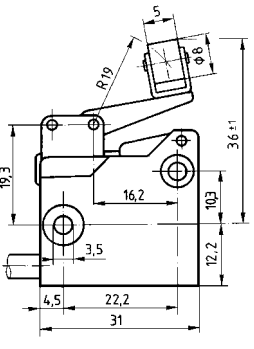
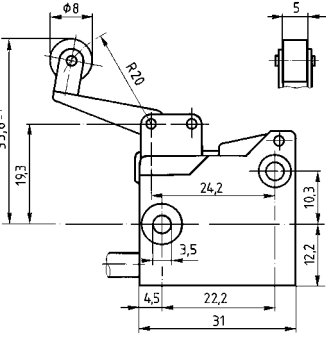
DESIGNATION	ACTUATING FORCE Fa max. (N)	RELEASE FORCE Fr min (N)	FREE POSITION Pr (mm)	OPERATING POSITION Pa (mm)	OVER-TRAVEL sr min. (mm)	DIFFERENTIAL MOVEMENT sd max. (mm)
 <p><b>MP320-5MAL/..</b></p>	3,0	1,0	35,6 ± 1,0	34,0 ± 0,6	2,5	0,80
 <p><b>MP320-5MAT/..</b></p>	3,0	1,0	36,0 ± 1,0	34,4 ± 0,6	2,5	0,80
 <p><b>MP320-5MBL/..</b></p>	3,0	1,0	35,6 ± 1,0	34,0 ± 0,6	2,5	0,80

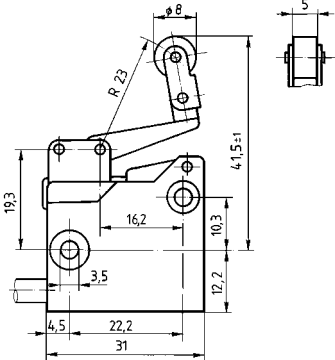
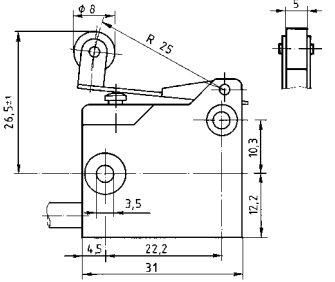
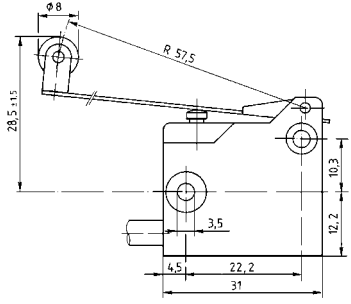
ACTUATING FORCE Fa max. (N)	RELEASE FORCE Fr min (N)	FREE POSITION Pr (mm)	OPERATING POSITION Pa (mm)	OVER-TRAVEL sr min. (mm)	DIFFERENTIAL MOVEMENT sd max. (mm)	DESIGNATION
3,0	1,0	41,5 ± 1,0	39,8 ± 0,6	2,5	0,80	MP320-6MAL/.. 
3,5	1,0	26,5 ± 1,0	25,7 ± 0,3	0,2	0,10	MP320-8ML25/.. 
1,3	0,3	28,5 ± 1,0	26,2 ± 0,8	0,5	0,80	MP320-8ML/.. 

# SERIES MP420 & DERIVATIVES

## MP420

### SEALED SUB-MINIATURE MICROSWITCH IP67

The sealed sub-miniature MP420 microswitch is a simple snap-action changeover switch, which is connected by means of a cable directly, overmoulded into the housing.

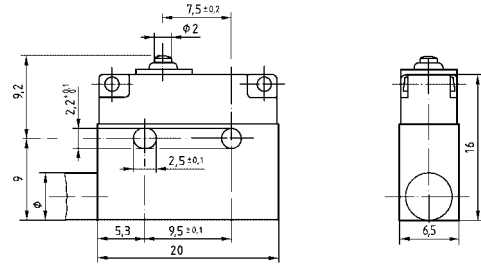

#### GENERAL CHARACTERISTICS, MP420 TYPES & DERIVATIVES

Approval	: ASE
Degree of protection	: IP67
Class of protection	: II
Micro-switching	: $\mu$
Contact-gap	: 0,4 mm
Up to standard	: EN61058 identical to VDE0630
Frequent functioning	: 50E3
Mechanical life	: $50 \times 10^6$ operations
Snap-action mechanism	: Stainless steel traction spring with beryllium copper contact leaf, self-cleaning contacts.
Dimensions	: DIN 41 635, B-form
Actuators	: Stainless steel

Lever actuators snap on to the MP420 microswitch by pressing the lever onto the lugs on the housing. When doing this, care has to be taken not to break the lugs. Check to ensure that the actuator is properly positioned on the lugs and that the lever pivots without rubbing.

#### CONNECTIONS cable or free wires depending on the type

Isolating material	PVC	RXL155	PVC
Code in the reference of the article	MP430	MP440	MP450
Cable	<b>X</b>		<b>X</b>
Free wires		<b>X</b>	

**REFERENCE CODE OF THE ARTICLE**

**SERIES MP420 & DERIVATIVES**

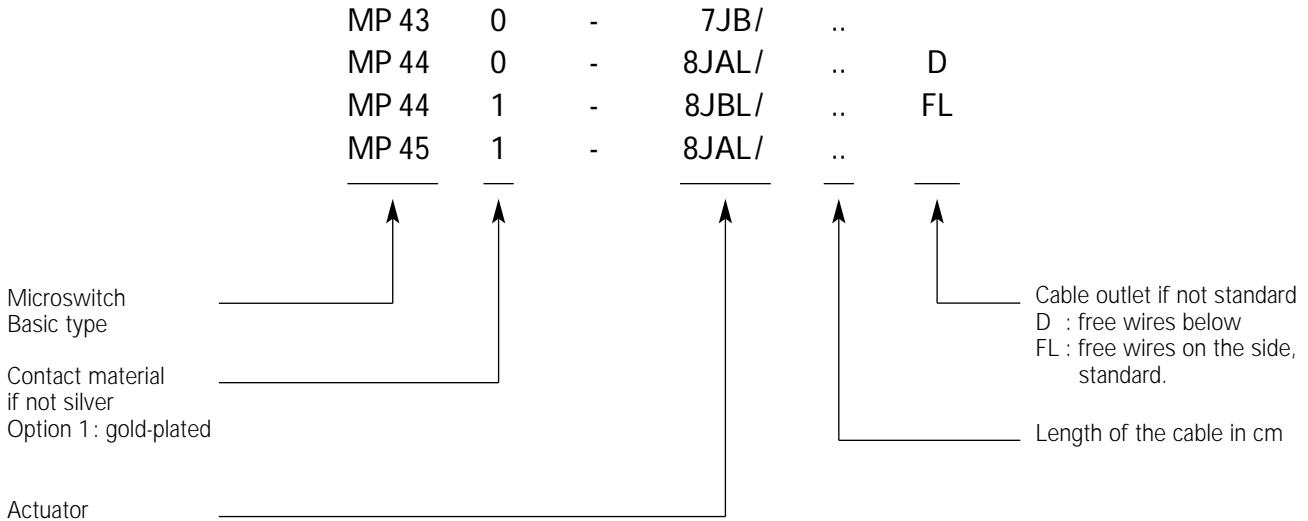

Housing:	PBT-ASA reinforced with glass fibre Auto-extinguishing according to UL94V-O	- 40°C to + 130°C
Membrane:	Fluorsilicone rubber MFQ	- 40°C to + 175°C
Cable:	PVC, grey sheath	- 20°C to + 70°C
Free wires:	RXL155, outlet D or FL (without identification)	- 55°C to + 155°C

**REFERENCE OF THE ARTICLE, SWITCHING RATING AND WIRING DIAGRAM**

Depending on the material of the electrical contacts and on the section of the conductors

Reference of the article	MP430	MP440	MP450
Section of the conductors	0.34 mm <sup>2</sup>	0.25 mm <sup>2</sup>	0.14 mm <sup>2</sup>
Ag contacts	2A 250VAC	2A 250VAC	1A 250VAC
Gold-plated contacts	0,1A 24VAC/DC		
Wiring diagram			

**REMARK:**  
The variant MP420, section of the conductors 0,50 mm<sup>2</sup> is cancelled, the demanded cable diameter is too big.

**CONNECTION**

By cables or supple wires

**Cable with standard outlet**

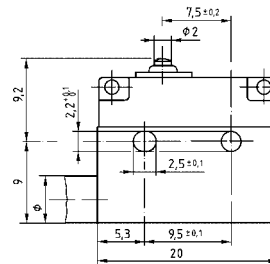

Examples :

- MP430-0/150
- MP450-0/200
- MP451-0/50

**Independent wire connection,  
standard side-outlet «FL»**

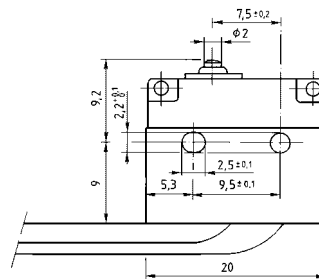

Examples :

- MP440-0/50FL
- MP441-0/100FL

**Independent wires,  
underside outlet «D»**

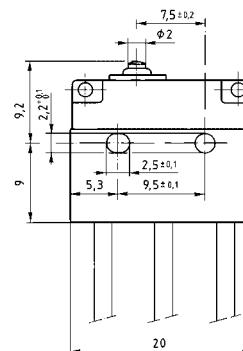

Examples :

- MP440-0/50D
- MP441-0/100D

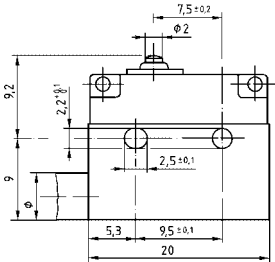
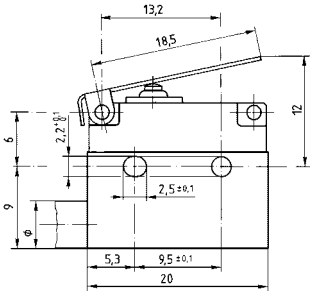
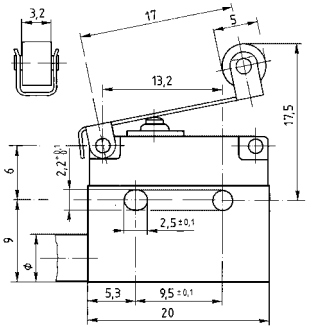
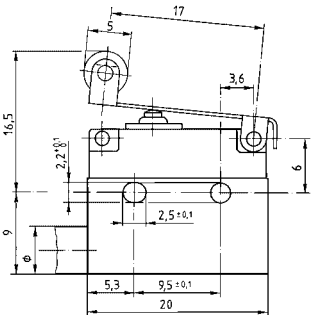
ACTUATING FORCE Fa max. (N)	RELEASE FORCE Fr min (N)	FREE POSITION Pr (mm)	OPERATING POSITION Pa (mm)	OVER-TRAVEL sr min. (mm)	DIFFERENTIAL MOVEMENT sd max. (mm)	DESIGNATION
2,5	0,5	9,2	8,4 ± 0,3	0,6	0,15	<b>MP430-0/..</b> <b>MP450-0/..</b> 
1,0	0,15	12,0	9,0 ± 1,0	1,2	0,60	<b>MP430-7JA/..</b> <b>MP450-7JA/..</b> 
1,0	0,15	17,5	14,8 ± 1,0	1,2	0,60	<b>MP430-8JAL/..</b> <b>MP450-8JAL/..</b> 
2,0	0,3	16,5	14,5 ± 0,6	0,8	0,40	<b>MP430-8JBL/..</b> <b>MP450-8JBL/..</b> 

# SERIES MP720 & DERIVATIVES



## MP720

### SEALED POSITION SWITCH WITH POSITIVE OPENING OPERATION OVERMOULDED CABLE - DEGREE OF PROTECTION IP67

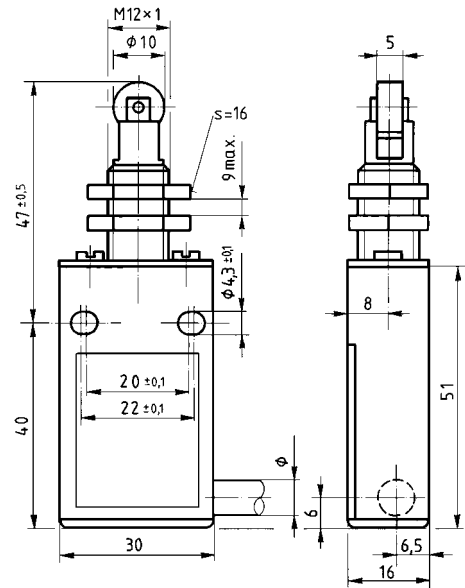
The MP720 positive opening position switch is a dependent-action, changeover, double-gap, contact element, which is connected by means of a cable directly overmoulded into the housing.



### GENERAL CHARACTERISTICS, MP720 TYPES

Approvals	: VDE SUVAPro N° E6204.d
Nominal switching capacity	: 6A 250VAC
Degree of protection	: IP67
Class of protection	: II
Reinforced insulation	: 
Positive break	: 
Complies with standards	: EN60947-1 as VDE 0660 part 100 EN60947-5 as VDE 0660 part 200
Mechanical life	: $10 \times 10^6$ operations
Frequency of operation	: 3600 operations per hour
Type of use	: AC15 (3A 240VAC) DC13 (0.27A 250VDC)
Assigned insulation voltage $U_i$	: 250VAC
Electrical protection	: 6A gI according to VDE 0636
Connection	: Cable directly overmoulded to the housing section $4 \times 0.75 \text{ mm}^2$
Overall dimensions	: DIN43695, EN 50047 and NFC 63-145, class Y2

# REFERENCE CODE OF THE ARTICLE

# SERIES MP720 & DERIVATIVES

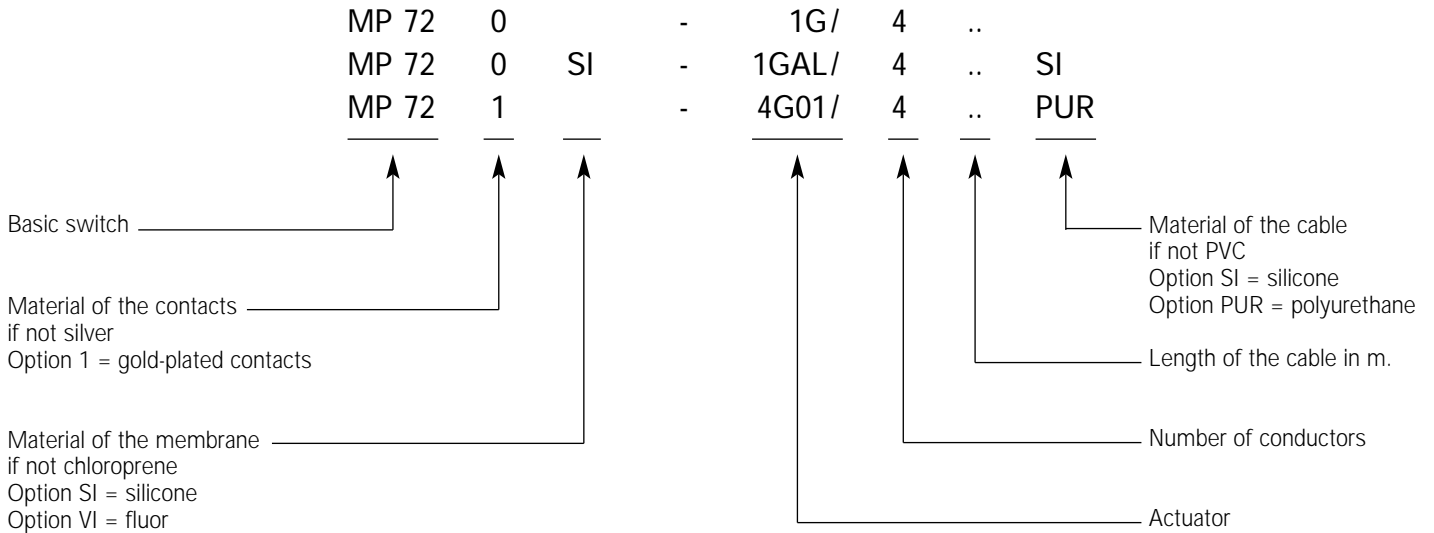

<b>Housing:</b>	PBT reinforced with glass fibre Auto-extinguishing according to UL94V-O	- 40°C to + 130°C
<b>Sealing membrane:</b>	Chloroprene rubber CR	- 20°C to + 80°C
	<b>SI</b> Silicone rubber	- 40°C to + 200°C
	<b>VI</b> Fluor rubber	- 05°C to + 150°C
<b>Cable:</b>	PVC	- 20°C to + 70°C
	<b>SI</b> Silicone rubber	- 40°C to + 150°C
	<b>PUR</b> polyurethane rubber	- 40°C to + 90°C

## SWITCHING DIAGRAM

Depending on the type of cable

Cable isolation	PVC	Polyurethane	Silicone
Code in the reference of the article		<b>PUR</b>	<b>SI</b>
Element of contact Za form			

*According to the availability of the market we reserve ourselves the right to modify the colors of identification of wire connection.*

11 - 12: Positive Break contact : positive opening operation.

23 - 24: Working contacts. They are designed for switching circuits and must never be used for breaking a safety circuit.

## COMMAND CHARACTERISTICS TERMINOLOGY

Additional definitions for the MP720.

### Pmp

Positive opening operation position. Actuator position at the point where the positive opening of the contacts is achieved.

Position of the actuator when the positive opening operation on the circuit-breaking contacts has been achieved. Position in, which pre-determined dielectric voltage rating requirements is met between the open contacts in the switchable circuit.

### smp

Positive opening operation travel. The minimum distance between the start of the movement of the actuator and the position where the positive opening of the contacts is achieved.

Distance between the rest position and the positive opening operation position.

### Fmp

Positive opening operation force. The actuating force applied to the actuator to cause it to achieve the positive opening operation.

## SAMPLES APPLICATIONS

### • Hinged door (rotating)

The problem with fitting a positive opening operation position switch to a hinged door is that the switch has to be operated as the door opens. Hence, the switch cannot be operated directly by the door but rather via a notched cam.

### • Sliding door (lateral movement)

In this case also the switch has to be operated as the door opens. Care has to be taken to ensure that the positive opening operation switch remains in that position during the full open travel of the door.

Protective doors of this type are generally used on machines operating at high revolutions with cooling fluids. Consequently, it is essential in such applications that a switch with IP67 protection be used.

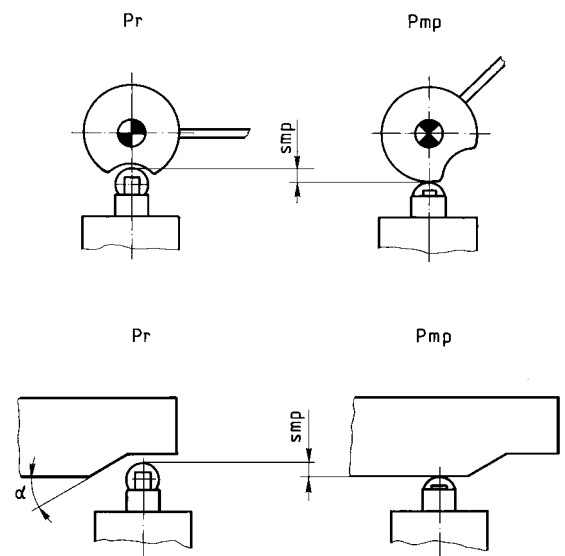

## FITTING INSTRUCTIONS

Additional instructions supplementing those on page 6 to 15.

When fitting **MP720** positive opening operation position switches, account has to be taken of the following points:

- The switch **must be actuated with the minimum positive opening operation travel (smp)** given for each type of actuator. This travel insures the opening of the contacts, hence the interruption of the circuit.
- The switch must be secured to a rigid support. Care must be taken to ensure that the retaining screws cannot work loose in use.
- The cam must be positioned and insured against maladjustment.
- The actuators must be set at the proper angle to avoid the accumulation of foreign bodies.
- Components must be correctly selected according to temperatures and chemical resistance.

**DOMED PLUNGER**

The actuator must be operated axially.  
Vertical button operating speed >1mm/s.

ACTUATING FORCE Fa max. (N)	POSITIVE OPENING FORCE Fmp min. (N)	FREE POSITION Pr (mm)	POSITIVE OPENING OPERATION POSITION Pmp max. (mm)	DESIGNATION	
4,0	10,0	20,5 ± 0,5	16,60	MP720-1G/4..	
4,0	10,0	35,0 ± 0,5	31,10	MP720-1GA/4..	

Switching diagram

\* = Positive opening operation travel (smp)

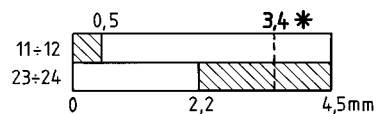

In free position, a clearance of 0.5 to 1.0 mm has to be left from the top of the actuating button.  
The plunger **must not** be used as a mechanical endstop.

Plunger actuators with a M12x1 male threaded collar must be secured by that collar using the nuts provided for that purpose.

### ROLLER PLUNGER

This may be operated by means of a rotating or sliding cam.

A cam the **angles of which are in excess of 40°** or the speed of which is in excess of **2m/s** must not strike the roller plunger.

The contact point must be directly above the axis of the roller.

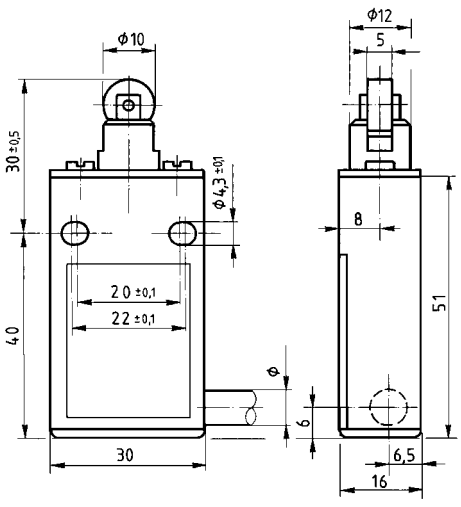
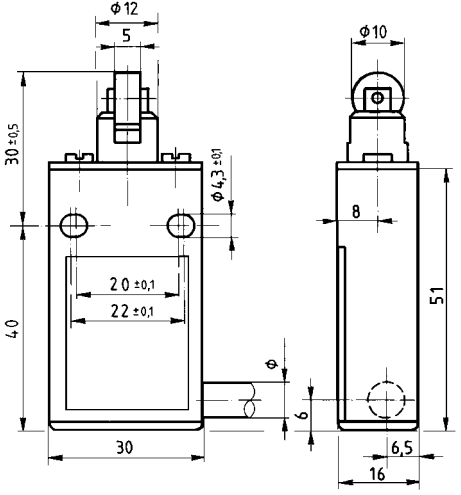
DESIGNATION	ACTUATING FORCE Fa max. (N)	POSITIVE OPENING FORCE Fmp min. (N)	FREE POSITION Pr (mm)	POSITIVE OPENING OPERATION POSITION Pmp max. (mm)
 MP720-1GL/4..	4,0	10,0	30,0 ± 0,5	26,10
 MP720-1GT/4..	4,0	10,0	30,0 ± 0,5	26,10

Switching diagram

\* = Positive opening operation travel (smp)

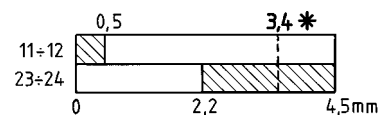

The strike angles and position must be so calculated as to avoid a violent shock to the roller; the cam must be so shaped as to ease the roller back to the free position.

4,0      10,0      47,0 ± 0,5      43,10

MP720-1GAL/4..

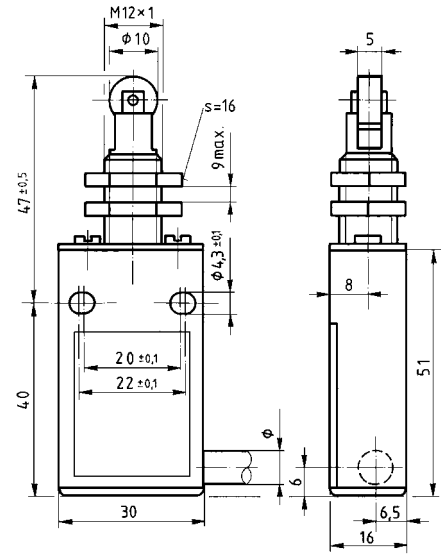

ACTUATING FORCE  
Fa max. (N)

POSITIVE OPENING FORCE  
Fmp min. (N)

FREE POSITION  
Pr (mm)

POSITIVE OPENING  
OPERATION POSITION  
Pmp max. (mm)

DESIGNATION

**ROLLER LEVER 4G**

The actuator 4G is recommended for rapid movements although sharp movements and shocks to the roller should be avoided. The lever must be eased back to the free position.

Strike angle: 30°

Maximum speed: 5m/sec.

1,0

2,5

0°

58°

MP720-4G01/4..

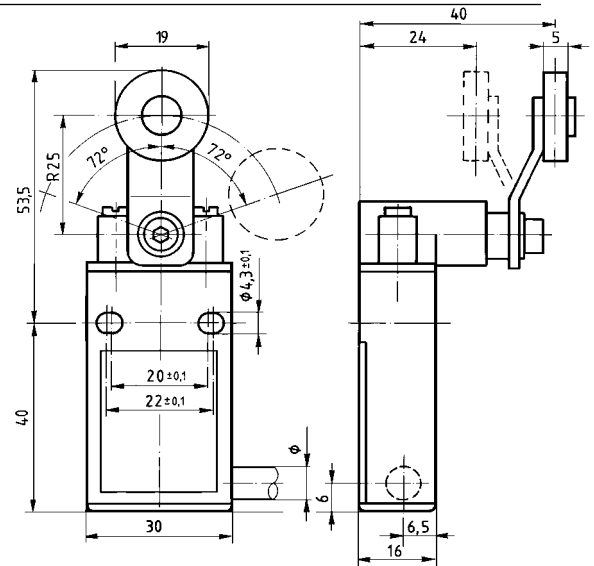

Switching diagram (4G..)

\* = Positive opening operation travel (smp)

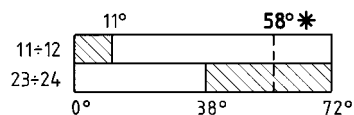

Reference of the article	Distance between the axis of the roller and the front face of the fixation screen
4G01	40 mm
4G02	24 mm
4G11	40 mm
4G12	24 mm